



GYNAECOLOGICAL AND OBSTETRIC INSTRUMENTS

Timesco[™]
SURGICAL + MEDICAL
INSTRUMENTS FOR LIFE[™]

CERTIFICATES AND APPROVALS

The TIMESCO OF LONDON LTD group of companies are registered, approved, hold licences or are authorised by organisations as listed below.

1. ISO 13488.



2. CE, certified notified body: CE 0120 Class I and IIa on selected products.



3. FDA No. 8021788. Registration as a manufacturer by USA Food and Drug Administration.
4. Timesco MID code: GM-TIM-LON-1-LON. Declaration: T2L
5. Various FDA registrations for worldwide governments.
6. Ministry of Defence (NATO) approved.
7. Registered in the UK and worldwide with various ministry of health departments and ministry of defense services.

CLASSIFICATION

Unless specified otherwise, TIMESCO products are classified under the harmonised tariff: 90-1890-8500.

Classification: Instruments medical and surgical/appliances/dental/veterinary.

TIMESCO'S LIFETIME GUARANTEE

All our reusable surgical instruments are guaranteed for life against faulty manufacture or materials.

Please note that we recommend regular maintenance of your instruments such as proper cleaning, lubricating etc. in order to extend their working life and validate our guarantee.

For our guarantee terms, please see our guarantee page in our price lists.



TIMESCO GYNAECOLOGICAL AND OBSTETRIC INSTRUMENTS



In this publication we have only illustrated the 'popular' instruments, which are used today. Timesco's range encompasses many additional Gynaecological and Obstetric instruments, which are listed either in our price lists or in additional literature.

General instruments which are used in all surgical procedures are not listed in this publication but are available in our General Surgical instruments catalogue separately.

Traditionally, English manufactured instruments were all finished in mirror polish. We have now followed the convention in North America and in Europe and are producing all our instruments in Satin (Matt finish). This is a gradual process and is being applied to all new manufactured product once current stocks are depleted.

In Gynaecology and Obstetrics, some products have always been made in soft metals (eg. brass) and then plated, eg. dilators and lumened items such as catheters. These are also as an ongoing process being replaced once stocks are depleted by stainless steel.

The joints on items which may currently exist in screw joint are also being replenished with box joints. These improvements, upgrades will be automatically done.

For diameters/gauges chart such as MM, French gauge (FG), English gauge (EG) and comparison between, please refer to the back of this publication. Any conversion of measurements in inches or MM from gauges have been rounded to the nearest whole numbers.

Unless specifically listed otherwise, all products listed are stainless steel. S/P=Silver Plated, C/P=Chromium Plated. **PLEASE READ NOTES (PAGE 3) ON NYLON INSULATED COATED ITEMS (BIC) AND LASER BLACK OXIDE COATED ITEMS BEFORE USE OR PROCESSING.**

For reprocessing and autoclaving, please refer to relevant Timesco data sheets.

The use, care and maintenance of products contained in this publication is limited to trained professionals only.

For Timesco's terms of trading, please refer to our price lists.



Each instrument is permanently marked with our Timesco logo as our guarantee of quality.

INSULATION COATED *BIC* ITEMS BLUE

Timesco produces many devices for electro medical procedures, loop, LETZ, Monopolar, Bipolar etc. In this publication we have only shown coated items which are used in Gynaecological and Obstetric procedures, separate publications are available on Bipolar, Monopolar and other electro medical procedures.

The *BIC* coated blue nylon insulating coatings are made from durable non-conductive nylons. They will not chip, peel or crack if used or cared for in the correct manner.

The *BIC* nylon insulation coated instruments for Gynaecological procedures are used in loop, LETZ excision procedures. The insulation prevents accidental contact of the loop device to the patient and surgeon, allowing procedures to be performed in complete safety.

All Timesco instruments with *BIC* insulation coating are double coated and far exceed industry standards. The instruments are leak tested for pin holes, damage and are guaranteed to be safe.

All cannulated items such as speculums, which have smoke extraction tubes fitted, may require filtration/smoke extraction units to be used with them.

A complete repair and recoating service is available on all Timesco *BIC* instruments.

All *BIC* coated items can be gently washed and autoclaved by steam autoclaving. Do not ultrasonic clean and do not sterilise by dry heat. Do not use any item, which has a dent, chip or cut on the coating due to any damage in use. **DO NOT USE BLUE-COATED ITEMS FOR LASER SURGERY.**



BLACK OXIDE COATED (LASER) ITEMS

Timesco provides in this publication a small selection of items which are black oxide coated and are for use in laser surgery. The black matt coating prevents laser bounce.

All cannulated items such as speculums, which have smoke extraction tubes fitted, may require filtration/smoke extraction units to be used with them.

All black-coated items can be gently washed and autoclaved by steam autoclaving. Do not ultrasonically clean and do not sterilise by dry heat. Do not use any item, which has a dent, chip or cut or a sign of steel showing through the coating, which could have occurred due to use or damage in preparation. **DO NOT USE BLACK-COATED ITEMS FOR LOOP LETZ PROCEDURES.**





SCISSORS - UMBILICAL CORD

BUSCH _____ 6
 AMERICAN _____ 6

SCISSORS - UTERINE

DUBOIS _____ 7
 FERGUSSON _____ 7
 SIMMS _____ 8
 UTERINE _____ 8

SCISSORS - EPISIOTOMY

LAWSON TAIT _____ 9
 BRAUN STADLER _____ 9

RETRACTORS

COMYN BERKELEY _____ 10
 DOYEN _____ 10
 DOYEN POZZI _____ 11
 GELPI _____ 11
 DOYEN (VAGINAL) _____ 12
 JOLL _____ 12
 LANDON _____ 13
 WERTHEIM _____ 13

HOOKS

IRIS _____ 14
 TIMESCO IRIS _____ 14

HORMONE TROCARS

TROCAR SETS _____ 14

CATHETERS

FEMALE _____ 14
 ROTUNDA _____ 14

NEEDLE EXTENSIONS

TIMESCO _____ 15

BLADDER SOUNDS

FEMALE _____ 15

VAGINAL CLAMPS

FEMALE _____ 15

DRESSING FORCEPS

BOZEMAN _____ 16
 VAGINAL _____ 16

SPECULUMS

AUVARD _____ 17
 COLLIN _____ 18
 CUSCO _____ 19
 CUSCO (SIDE SCREW) _____ 20
 CUSCO (LASER) _____ 21
 GRAVES _____ 22-23
 GRAVES (WIDE) _____ 23-24
 WEISMAN GRAVES _____ 25-27
 PEDERSON _____ 27-28

SIMS (SINGLE ENDED) _____ 29-30
 SIMS (DOUBLE ENDED) _____ 30-32
 WINTERTON _____ 33

LATERAL WALL RETRACTORS

TIMESCO (VAGINAL) _____ 34-35

BIOPSY FORCEPS

BURKE _____ 36
 EPPENDORF _____ 36
 FAURE _____ 37
 KEVORKIAN YOUNG _____ 37
 LEECH WILKINSON _____ 37
 SCHUBERT _____ 38
 SCHUMACHER _____ 38-39
 TISCHLER _____ 39-40
 VAN DORAN _____ 40
 WITTNER _____ 40

DILATORS

BONNEY-BARKER _____ 41
 HANK _____ 41
 HAWKIN AMBLER _____ 42
 HEGAR _____ 42-43
 PRATT _____ 43

ENDOCERVICAL SPECULUMS

KOGAN _____ 44

TENACULUM/VULSELLUM FORCEPS

ATRAUMA _____ 44
 TIMESCO ATRAUMA _____ 44
 CERVICAL _____ 45
 TIMESCO VULSELLUM _____ 45
 BIERER _____ 45
 BRAUN _____ 46
 DUPLAY _____ 46
 LEWER _____ 46
 LUER _____ 47
 TIMESCO LUER _____ 47-48
 ROTUNDA _____ 48
 SCHROEDER _____ 48
 TEAL _____ 49

HOOKS

EMETT _____ 49
 3 PRONG _____ 49
 WHITTAKER _____ 49

ENDOCERVICAL CURETTES

KEVORKIAN _____ 50

UTERINE CURETTES

RECAIMER _____ 51-54
 SIMS (SINGLE ENDED) _____ 55
 SIMS (DOUBLE ENDED) _____ 55

Continued Overleaf...

FLUSHING CURETTES

RHEINSTADTER _____ 56

BIOPSY CURETTES

LEECH WILKINSON _____ 56

NOVAK _____ 57

RANDALL _____ 57

SHARMAN _____ 57

DEPRESSORS

BRAUN _____ 58

SIMS _____ 58

UTERUS HOLDING FORCEPS

COLLIN _____ 59

DARTIGUE _____ 59

SOMER _____ 59

HYSTERECTOMY CLAMPS

BONNEY _____ 60

BONNEY-BERKLEY _____ 60

GWILLIAM _____ 60

HEANEY _____ 61

HUNTER _____ 61

MAINGOT _____ 61

MCCULLAGH _____ 62

NAVRATILL _____ 62

WERTHEIM _____ 62

TIMESCO PARAMETRIUM _____ 63

INSUFFLATION CANNULAS

CURRIE _____ 63

HAYES-PROVIS _____ 63

LEECH WILKINSON _____ 64

PROVIS _____ 64

SPACKMAN _____ 64

MYOMA SCREWS

DOYEN MYOMA _____ 65

MYOMECTOMY CLAMPS

BONNEY _____ 65

POLYPUS FORCEPS

BONNEY POLYPUS _____ 66

KELLY POLYPUS _____ 66

TIMESCO POLYPUS _____ 66

UTERINE SOUNDS

GALABIN _____ 67

HORROCK _____ 67

SIMPSON _____ 67

SIMS _____ 68

IUCD UTERINE HOOKS

GRAFENBERG _____ 65

IUCD REMOVAL FORCEPS

TIMESCO _____ 68

CAESAREAN SECTION FORCEPS

GREEN-ARMYTAGE _____ 69

INDUCTION CATHETERS

DREW SMYTHE _____ 69

CRANIO AND CEPHALO

BRAUN _____ 70

WINTER _____ 70

UTERUS EVACUATION/ ASPIRATION CURETTES

BIERER _____ 70

INDUCTION FORCEPS

GOODWIN _____ 71

OBSTETRIC FORCEPS

ANDERSON _____ 71

BARNES NEVILLE _____ 71

DE LEE _____ 72

HAIG FERGUSON _____ 72

KIELLAND _____ 72

KIELLAND LUIKART _____ 72

MILNE MURRAY _____ 73

SIMPSON _____ 73

TARNIER _____ 73

WRIGLEY _____ 73

MUCOUS EVACUATORS

CARTON _____ 74

OVUM/PLACENTA FORCEPS

BIERER _____ 74

GREENHALGH _____ 74

HEYWOOD SMITH _____ 75

MCLINTOCK _____ 75

WILLETT _____ 75

PELVIMETERS

BREISKY _____ 76

MARTIN _____ 76

PERFORATORS

DENMAN _____ 77

SIMPSON _____ 77

UMBILICAL DILATORS _____ 77

STETHOSCOPES

PINARD _____ 77



12.230.25 BUSCH UMBILICAL CORD STRAIGHT 5" (13CM)

12.230.50 BUSCH UMBILICAL CORD CURVED TO SIDE 5" (13CM)

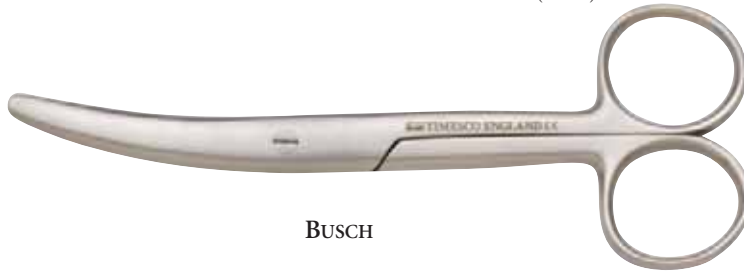

BUSCH

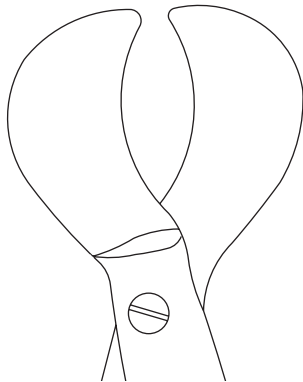

12.690.25 UMBILICAL CORD AMERICAN 4.25" (10.5CM)



AMERICAN

Timesco Umbilical Cord scissors, like all Timesco scissors feature super sharp cutting edges, which allow ease in cutting and minimal finger fatigue.

By far the most popular Umbilical Cord scissors are the 'American' pattern. This scissors feature 'parrot faced' curved inwards concave cutting edges which prevent the cord from slipping during shearing.

SCISSORS - UTERINE

Timesco Uterine scissors are powerful cutting instruments all of which feature strong shanks and thick blades, which can incise thick muscular tissue with ease in Gynaecological and Obstetric procedures.



12.360.25 DUBOIS STRAIGHT 10.5" (27CM)

12.360.50 DUBOIS CURVED 10.5" (27CM)

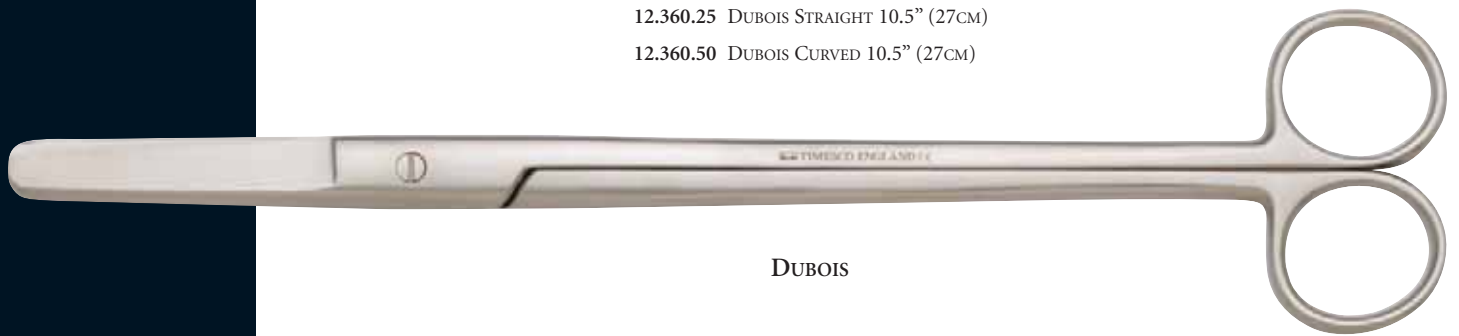

DUBOIS

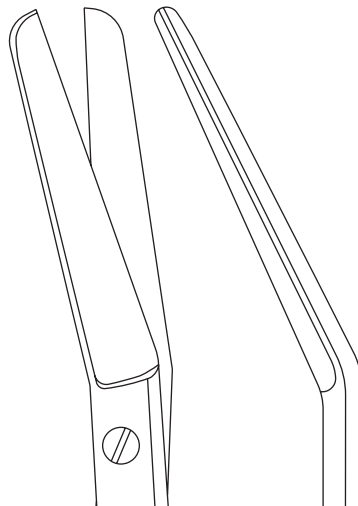

12.395.10 FERGISSON UTERINE ANGLED 6.5" (16.5CM)

12.395.20 FERGISSON UTERINE ANGLED 7" (18CM)

12.395.30 FERGISSON UTERINE ANGLED 8.25" (21CM)

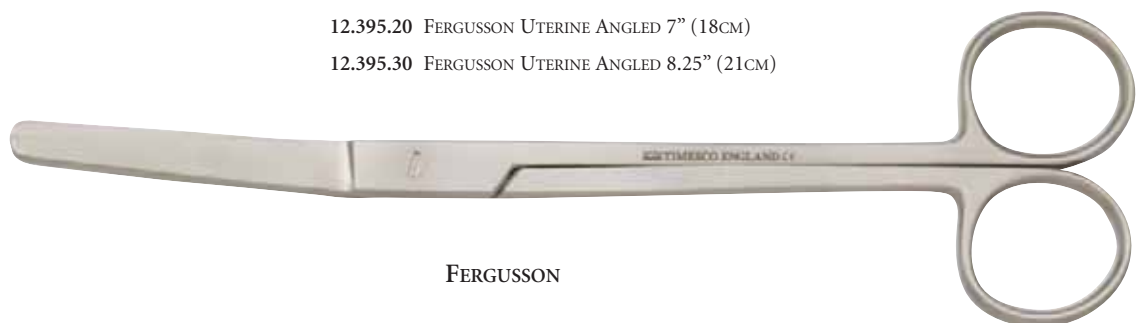

FERGISSON

All Timesco cutting instruments are made from especially hardened and tempered steel to provide durable performance.

Uterine scissors are also available in Tungsten Carbide cutting edges, please see separate catalogue.



12.640.25 SIMS UTERINE STRAIGHT 9" (23CM) BLUNT/BLUNT

12.640.50 SIMS UTERINE CURVED 9" (23CM) BLUNT/BLUNT



SIMS



12.700.10 UTERINE STRAIGHT 9" (23CM) BLUNT/BLUNT

12.700.20 UTERINE CURVED 9" (23CM) BLUNT/BLUNT



UTERINE

SCISSORS - EPISIOTOMY

Timesco Episiotomy scissors feature thick strong and powerful blades for efficient clean shearing in Episiotomy procedures.

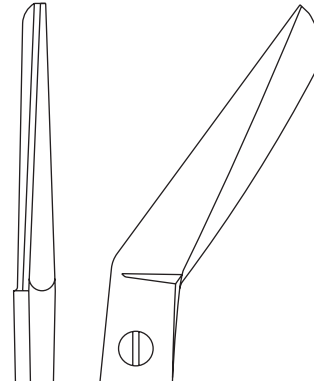

12.475.25 LAWSON TAIT EPISIOTOMY 5.5" (14CM)



LAWSON TAIT

Episiotomy scissors feature angled blades to allow easier access to the perinium. The peculiarly offset ringed 'Lawson Tait' scissors are also known as 'Barnes'.

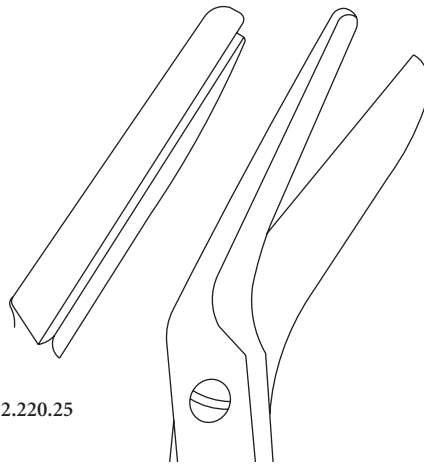

12.220.25

12.220.25 BRAUN STADLER EPISIOTOMY 5.5" (14CM)

12.220.50 BRAUN STADLER EPISIOTOMY 8.75" (22CM)

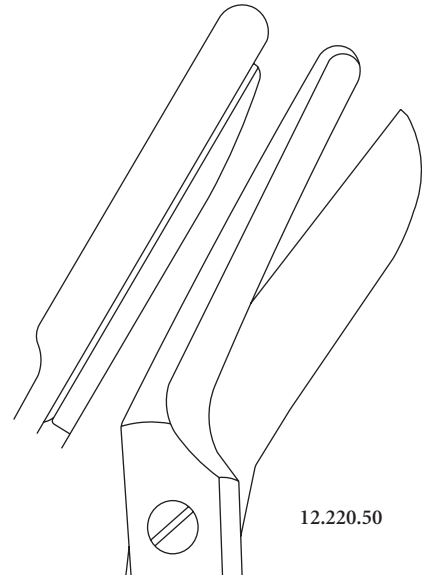

12.220.50

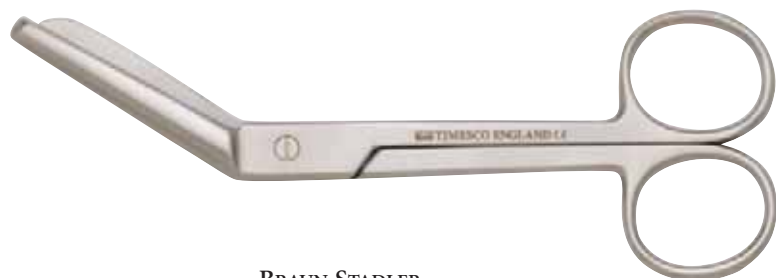

BRAUN STADLER

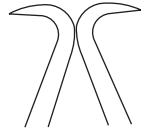

15.160.10 COMYN BERKELEY VULVA SELF RETAINING 6" (15.5CM)



COMYN BERKELEY

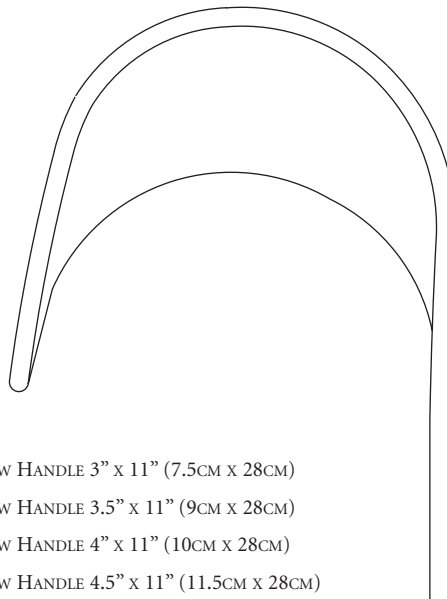

- 15.215.10 DOYEN SUPRA HOLLOW HANDLE 3" x 11" (7.5CM x 28CM)
- 15.215.20 DOYEN SUPRA HOLLOW HANDLE 3.5" x 11" (9CM x 28CM)
- 15.215.30 DOYEN SUPRA HOLLOW HANDLE 4" x 11" (10CM x 28CM)
- 15.215.40 DOYEN SUPRA HOLLOW HANDLE 4.5" x 11" (11.5CM x 28CM)

The Doyen retractors in particular are very practical and useful instruments in procedures for caesarean sections and abdominal wall retraction in myomectomies / hysterectomies etc.

The large curved edges on the sides of the blades retract the abdominal wall very effectively allowing maximum exposure.



DOYEN

RETRACTORS

Many varieties of 'general retractors' are used not only in vaginal but abdominal Gynaecological and Obstetric procedures, we have only listed some popular designs in this catalogue.

29
27
26
25
24
23
22
21
20
19
18
17
16
15
14
13
12
11
10
9
8
7
6
5
4
3
2

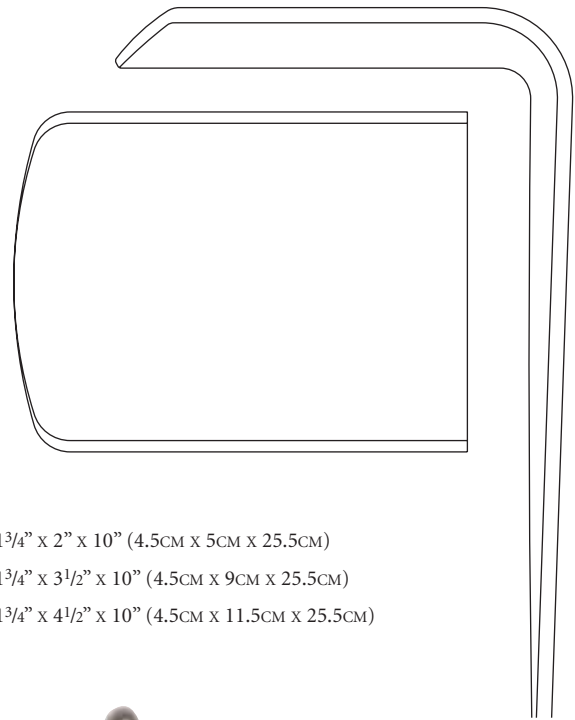

- 15.235.10 DOYEN POZZI 1³/₄" x 2" x 10" (4.5CM x 5CM x 25.5CM)
- 15.235.20 DOYEN POZZI 1³/₄" x 3¹/₂" x 10" (4.5CM x 9CM x 25.5CM)
- 15.235.30 DOYEN POZZI 1³/₄" x 4¹/₂" x 10" (4.5CM x 11.5CM x 25.5CM)

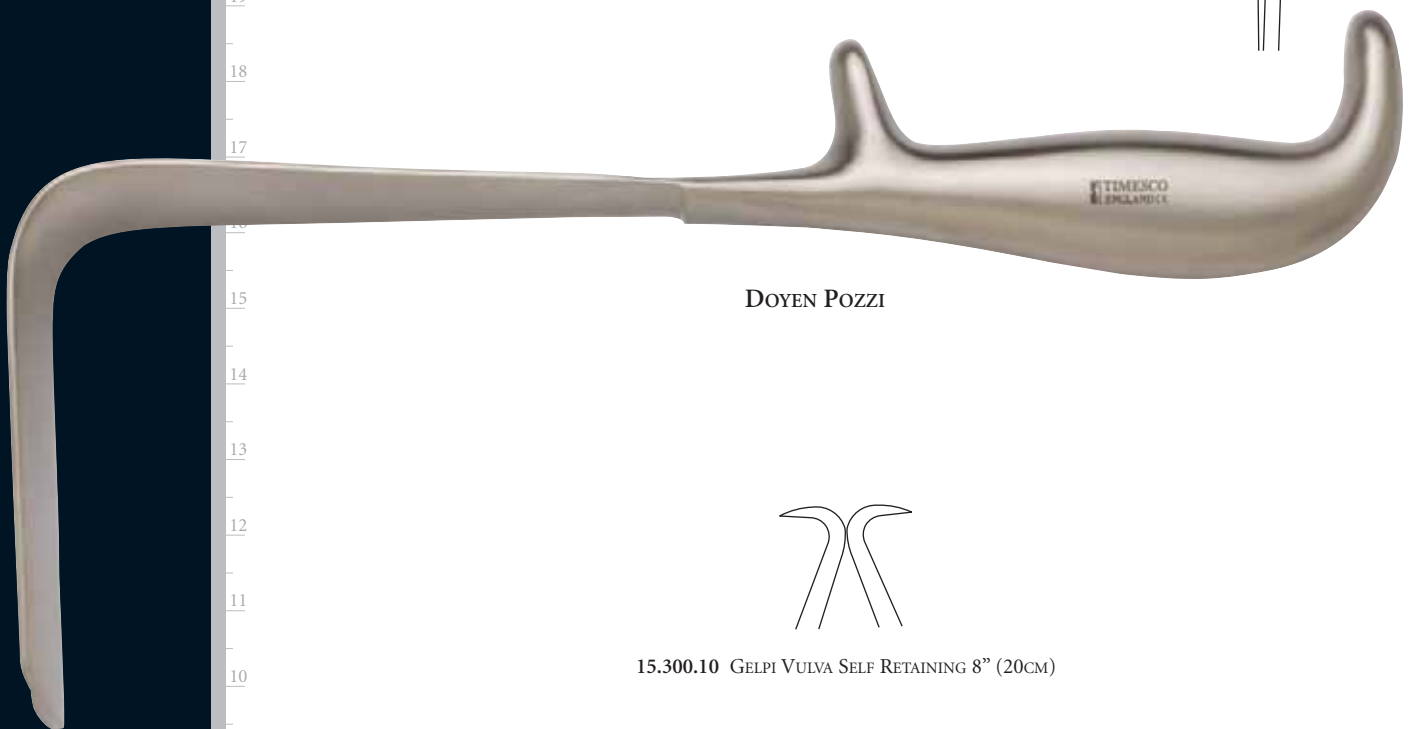

DOYEN POZZI

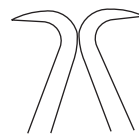

15.300.10 GELPI VULVA SELF RETAINING 8" (20CM)

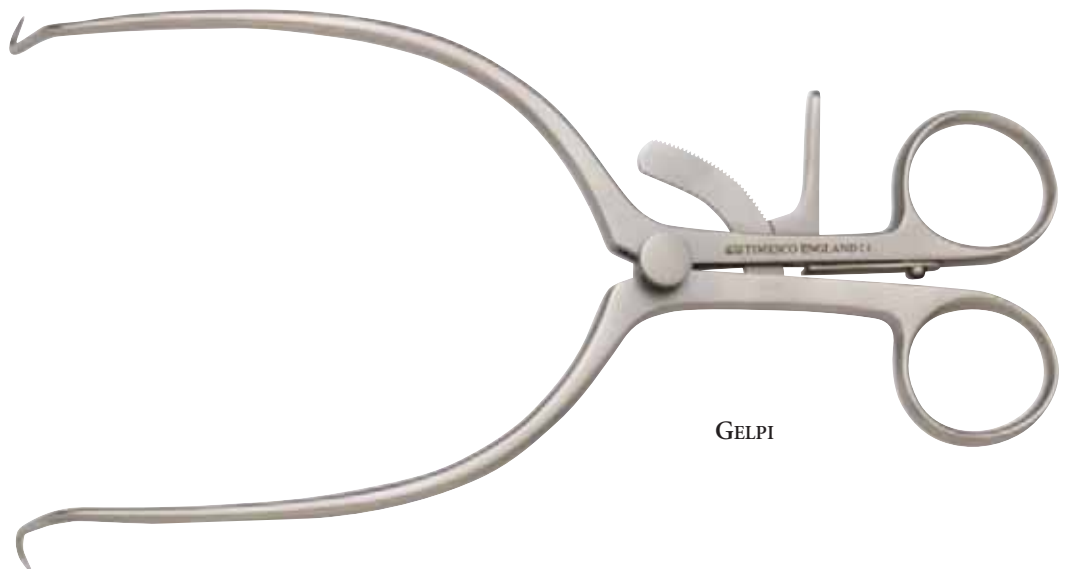

GELPI

Vulva retractors, such as Gelpi, Blair and Joll (Thyroid) feature sharp pin jaws which affix to the vulva walls, allowing unaided retraction and minimum trauma.

RETRACTORS

DOYEN

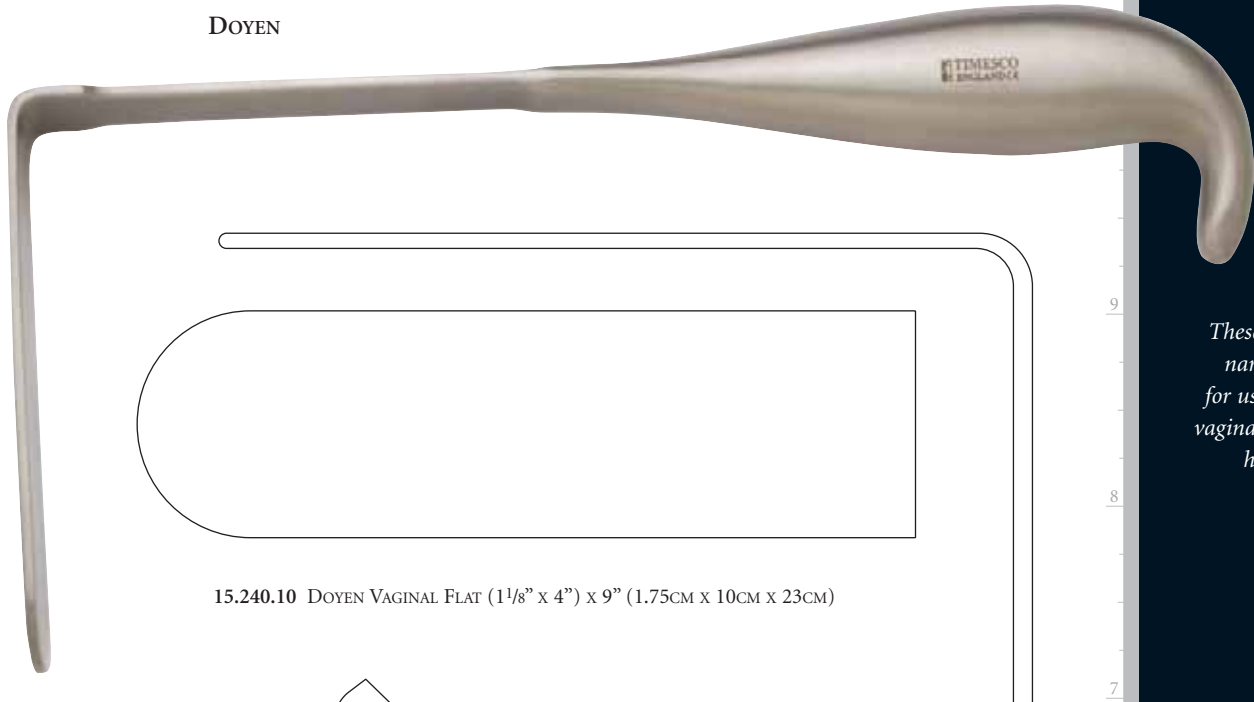

15.240.10 DOYEN VAGINAL FLAT (1 1/8" x 4") x 9" (1.75CM x 10CM x 23CM)

These feature long narrow blades, for use through the vaginal walls and are hand held.

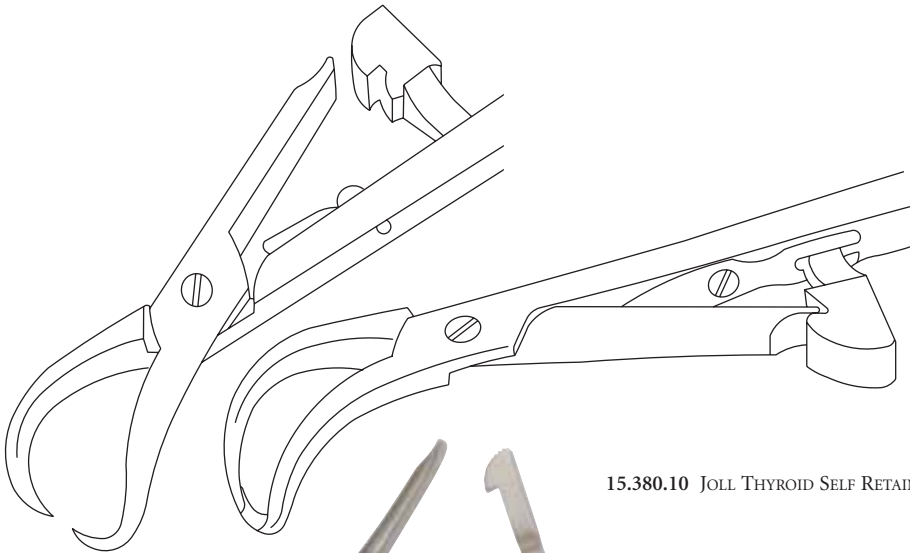

15.380.10 JOLL THYROID SELF RETAINING 6" (15.5CM)

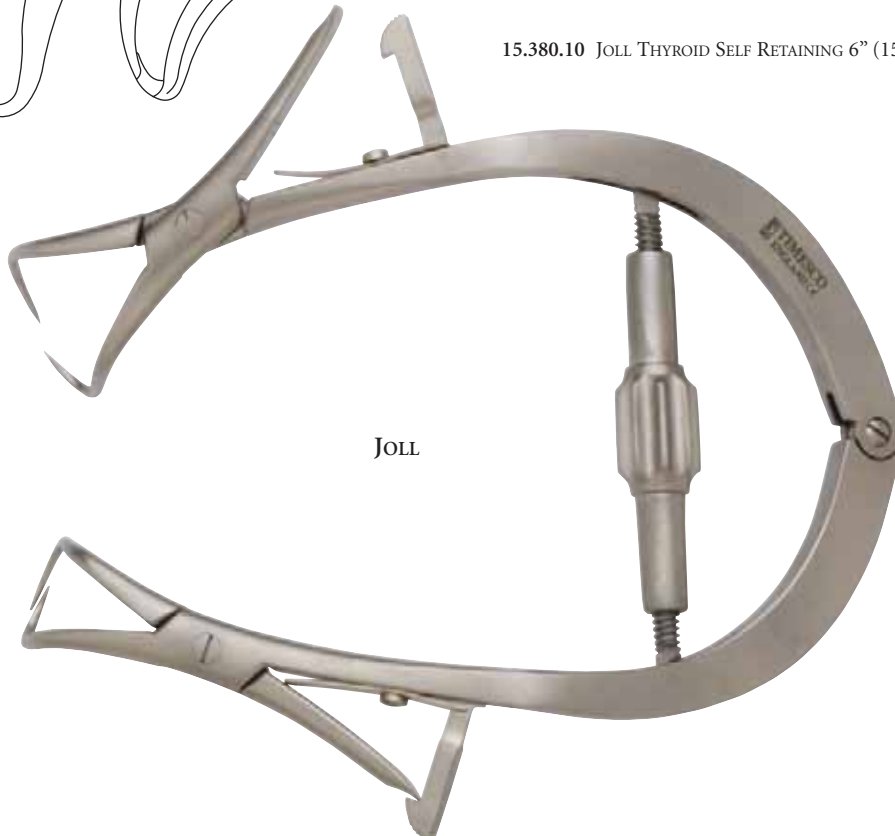

JOLL



The complete retractor range is available in our 'general surgical' sections.

RETRACTORS

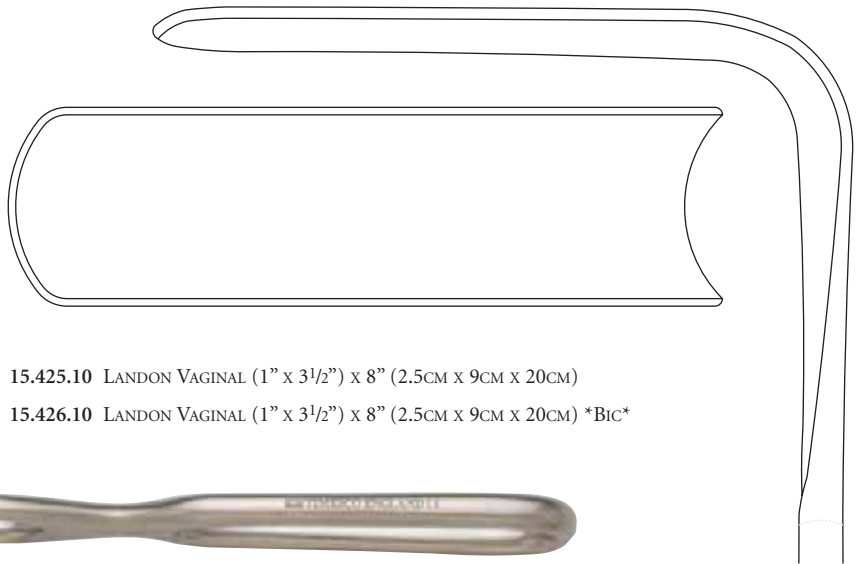

15.425.10 LANDON VAGINAL (1" x 3 1/2") x 8" (2.5CM x 9CM x 20CM)

15.426.10 LANDON VAGINAL (1" x 3 1/2") x 8" (2.5CM x 9CM x 20CM) *BIC*

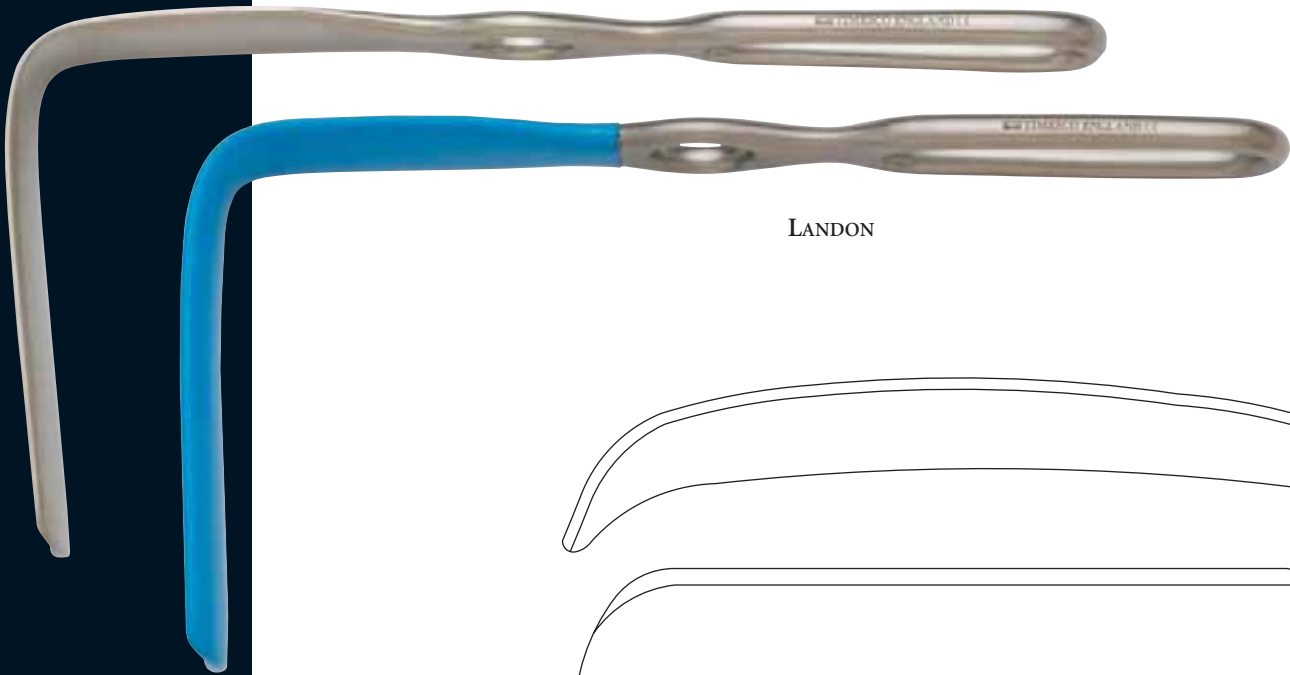

LANDON

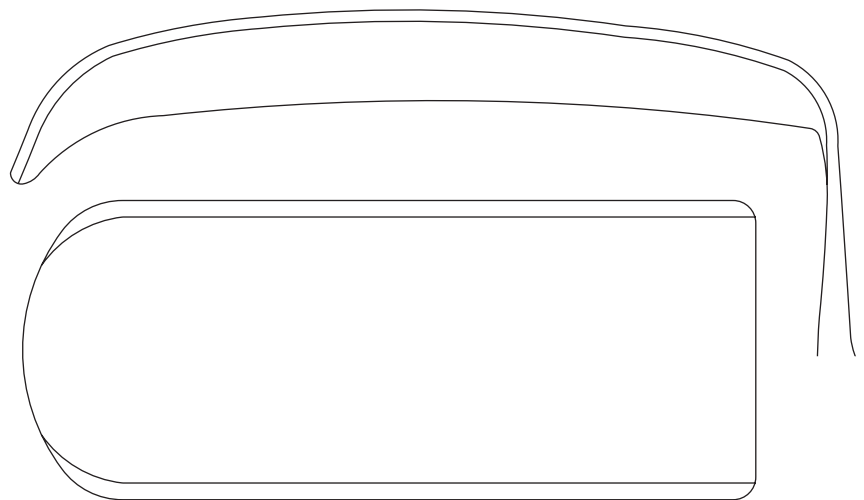

WERTHEIM

Wertheim retractors are also known as 'Breisky' and 'Vienna' patterns.

15.670.10 WERTHEIM (1 1/2" x 3 3/4") x 10 3/4" (3CM x 9.5CM x 27.5CM)

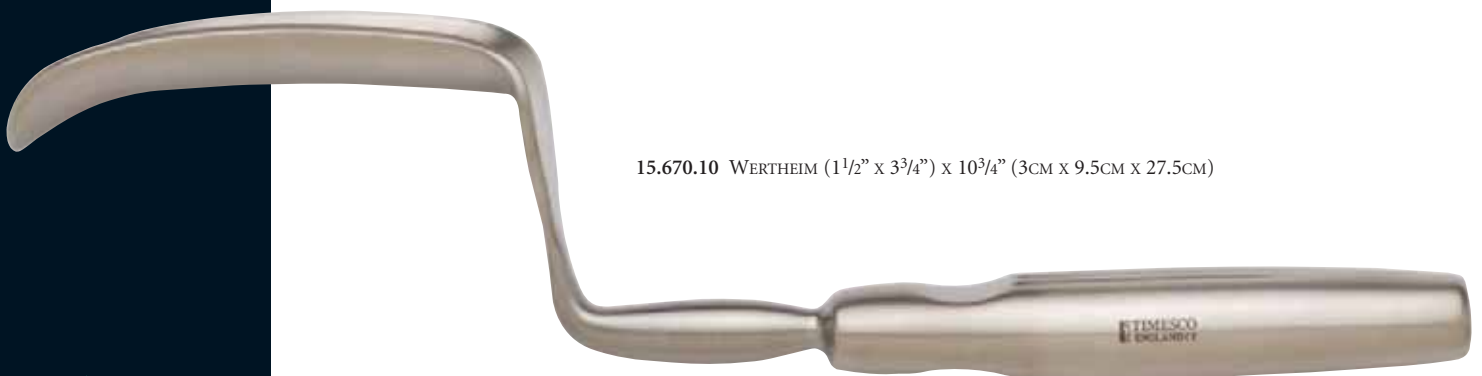

HOOKS

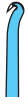

15.918.20 IRIS SKIN HOOK 7" (18CM) FINE *BIC*



15.919.20 TIMESCO IRIS SKIN HOOK 10" (25.5CM) FINE *BIC*

Also see Teneculum hooks on page 49.

For Loop LETZ procedures we also provide unique new hooks which are coated with insulation *BIC* coating. The tips of the hooks are uncoated for gripping the tissue.

HORMONE TROCARS

○ 5mm



21.250.10 HORMONE IMPLANT TROCAR SET 5MM X 25MM CANNULA, 4.5" (11.5CM)

21.250.20 HORMONE IMPLANT TROCAR SET 5MM X 50MM CANNULA, 5.5" (14CM)

21.250.30 HORMONE IMPLANT TROCAR SET 5MM X 80MM CANNULA, 6.75" (17CM)

For H.R.T. (hormone replacement treatment), hormone pellets are introduced under the skin to introduce progesterone, testosterone and oestradiol. Timesco manufactures three of the most popular sizes, each supplied complete with pellet introducing rods.

CATHETERS

FEMALE



- 6EG 4mm
- 7EG 4.5mm
- 8EG 5mm
- 9EG 5.5mm
- 10EG 6mm

57.100.10 FEMALE 6" (15.5CM) 6EG S/P

57.100.20 FEMALE 6" (15.5CM) 7EG S/P

57.100.30 FEMALE 6" (15.5CM) 8EG S/P

57.100.40 FEMALE 6" (15.5CM) 9EG S/P

57.100.50 FEMALE 6" (15.5CM) 10EG S/P

The traditional 'female' and 'Rotunda' catheters for evacuation of the bladder are still available from Timesco despite many of these applications having been transferred to disposable plastic.

ROTUNDA



- 8EG 5mm
- 10EG 6mm

57.120.10 ROTUNDA FEMALE 7.5" (19CM) 8EG S/P

57.120.20 ROTUNDA FEMALE 7.5" (19CM) 10EG S/P

The catheters are made from toughened tube and then electroplated with silver. Stillettes for cleaning are supplied with all Timesco catheters.

NEEDLE EXTENSIONS

The size of the injection needles is often not long enough to inject the Para cervical or vaginal tissue in some procedures. Timesco produces three sizes of needle extensions, which can be used on the syringe to extend the working length of the needle. Needle extensions have luer lock fittings.



57.125.10 TIMESCO 3" (7.5CM) LEUR

57.125.20 TIMESCO 4" (10CM) LEUR

57.125.30 TIMESCO 5" (13CM) LEUR

BLADDER SOUNDS

We are illustrating these, but these are now rarely used.

The word 'sound' is a misnomer – it is a relic from the early days of surgery when a Bougie was said to have made a 'sound' when it made contact with stones in the bladder! etc.



- 6EG 4mm
- 8EG 5mm
- 10EG 6mm
- 12EG 7mm

57.130.20 FEMALE 6EG 9½" (24CM)

57.130.30 FEMALE 8EG 9½" (24CM)

57.130.40 FEMALE 10EG 9½" (24CM)

57.130.50 FEMALE 12EG 9½" (24CM)

VAGINAL CLAMPS



57.150.20 BONNEY 13.5" (34.5CM) SCREW JOINT

There are two 'Bonney' clamps, which are used for uterine applications. These forceps feature powerful clamping action, double finger rings and strong interlocking positive ratchets. This clamp was originally made for the classic 'Wertheim's operation'.

DRESSING FORCEPS

These forceps are available in a variety of jaw configurations and their principal use is in 'packing' (swab/gauge) in Gynaecological procedures. The Bozeman forceps are multipurpose instruments and are also used for holding/introducing catheters/drains etc.

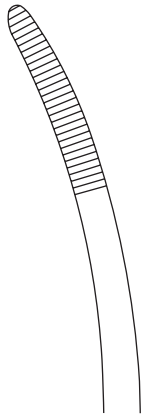

57.170.20

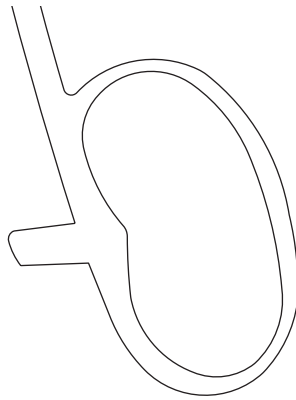

57.170.30

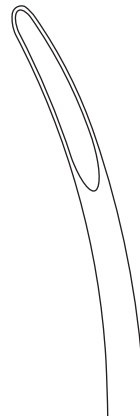

57.170.40

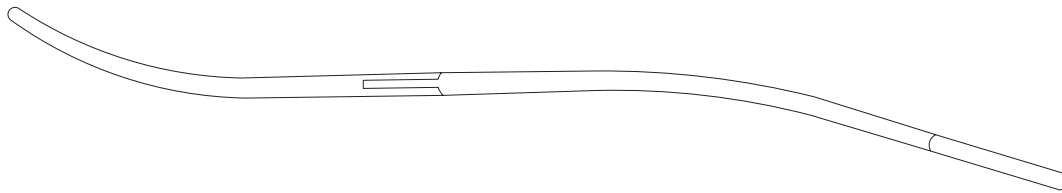

57.170.20 BOZEMAN SERRATED 10.5" (27CM) BOX JOINT

57.170.30 BOZEMAN LARGE BOW SERRATED 10.5" (27CM) BOX JOINT

57.170.40 BOZEMAN GROOVED 10.5" (27CM) BOX JOINT



BOZEMAN



57.190.20 VAGINAL 9.5" (24CM) SERRATED



SPECULUMS

From the simple retractor type 'Sims' speculum to the bivalve Cusco, Graves etc., Timesco manufacture an extensive range of speculums.

Speculums are basic vaginal retractors, and open the vagina for exposure of the cervix etc.

If speculum sizes have been stated they are width x length.

Wherever outline drawings of speculum blade sizes and rear profiles are given, for illustrative purposes, a 'medium' speculum size is used wherever available.

29
27
26
25
24
23
22
21
20
19
18
17
16
15
14
13
12
11
10
8
7
6
5
4
3
2

- 57.235.20 AUVARD SMALL FIXED WEIGHT 38MM X 75MM
- 57.235.40 AUVARD LARGE FIXED WEIGHT 38MM X 105MM
- 57.235.45 AUVARD LARGE FIXED WEIGHT 38MM X 105MM *BIC*
- 57.235.60 AUVARD SMALL LOOSE WEIGHT 38MM X 75MM
- 57.235.80 AUVARD LARGE LOOSE WEIGHT 38MM X 105MM

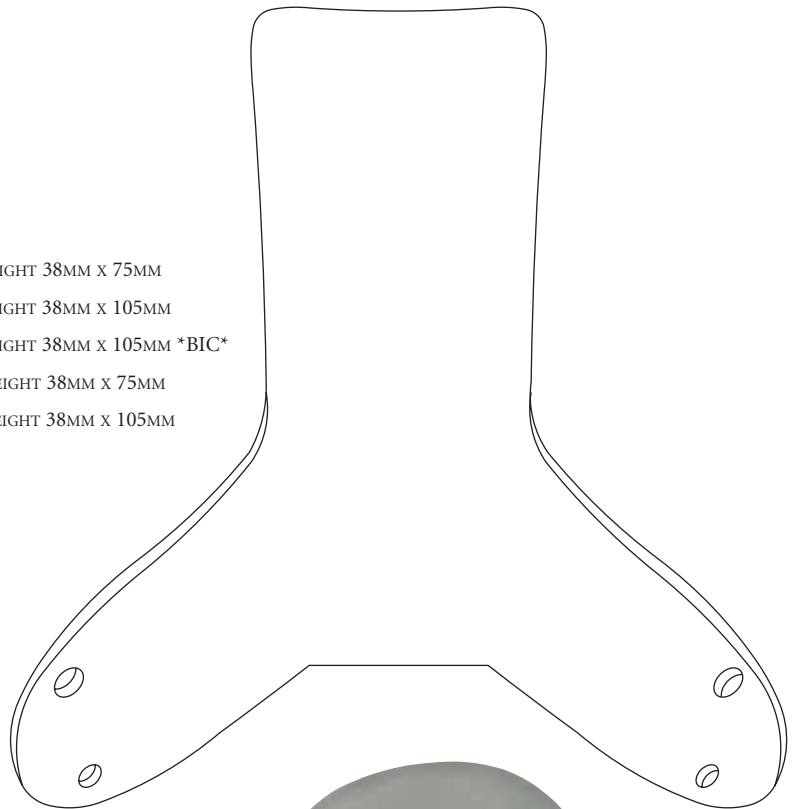

57.235.40

57.235.45

57.235.80

AUVARD

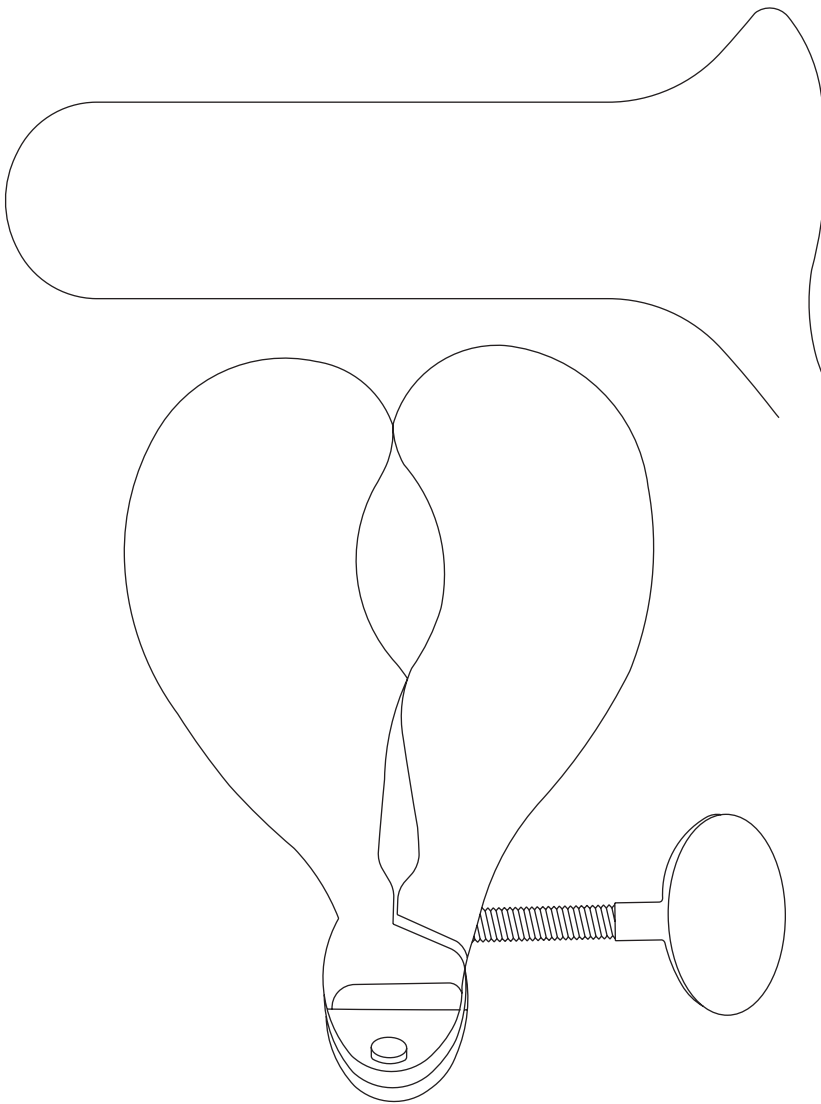

- 57.280.20 COLLIN SMALL 30MM X 85MM
- 57.280.40 COLLIN MEDIUM 35MM X 100MM
- 57.280.60 COLLIN LARGE 40MM X 110MM



COLLIN

Speculums vary in size and pattern but function is the same. Some speculums, eg. Auvars, also feature 'weighted' handles, which allow unaided retraction.

SPECULUMS



Timesco offer both versions of the classic speculum: Cusco, these are available in the traditional British through the handle screw lock arrangement and the Continental 'side screw' pattern.

All Timesco speculums are now manufactured in stainless steel only.

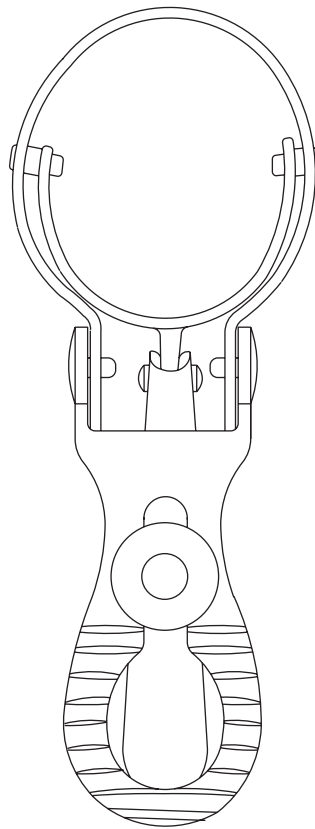
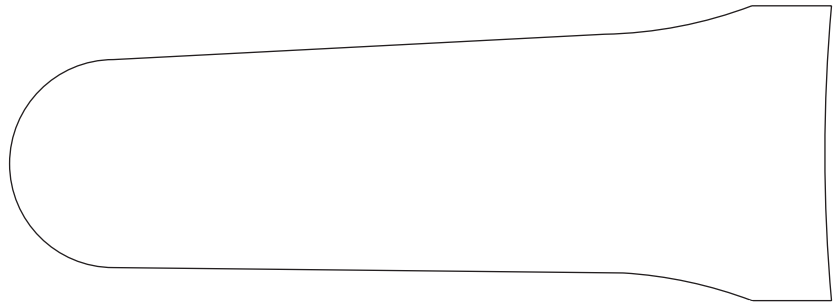

- 57.295.10 CUSCO VIRGIN 15MM X 65MM
- 57.295.13 CUSCO VIRGIN LONG 15MM X 85MM
- 57.295.15 CUSCO SMALL 25MM X 80MM
- 57.295.20 CUSCO MEDIUM 30MM X 90MM
- 57.295.25 CUSCO MEDIUM LONG 30MM X 115MM
- 57.295.30 CUSCO LARGE 35MM X 95MM



Cusco

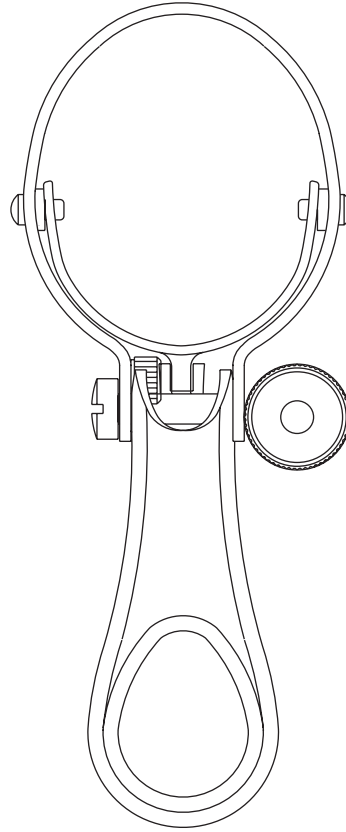
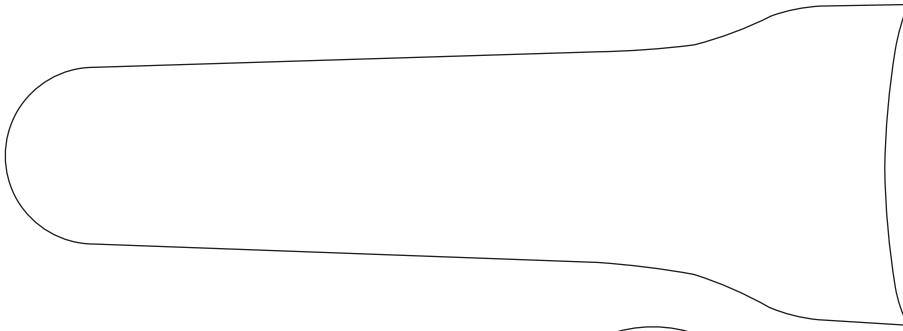

- 57.300.20 CUSCO VIRGIN SIDE SCREW 17MM X 75MM
- 57.300.30 CUSCO SMALL SIDE SCREW 22MM X 80MM
- 57.300.40 CUSCO MEDIUM SIDE SCREW 25MM X 100MM
- 57.300.50 CUSCO LARGE SIDE SCREW 27MM X 105MM

*This side screw
Cusco patterns are
also referred to
as 'Swiss pattern'.*



Cusco

SPECULUMS

We also supply speculums with a 'Black coating'. This is a special oxide non-reflective coating for use in laser surgery only.

All black-coated items can be gently washed and autoclaved by steam autoclaving. Do not ultrasonically clean, and do not sterilise by dry heat. Do not use any item, which has a dent, chip or cut or a sign of steel showing through the coating, which could have occurred due to use or damage in preparation. Do not use black-coated items for Loop LETZ procedures.

All black oxide coated laser speculums are supplied with fitted smoke extraction tubes.

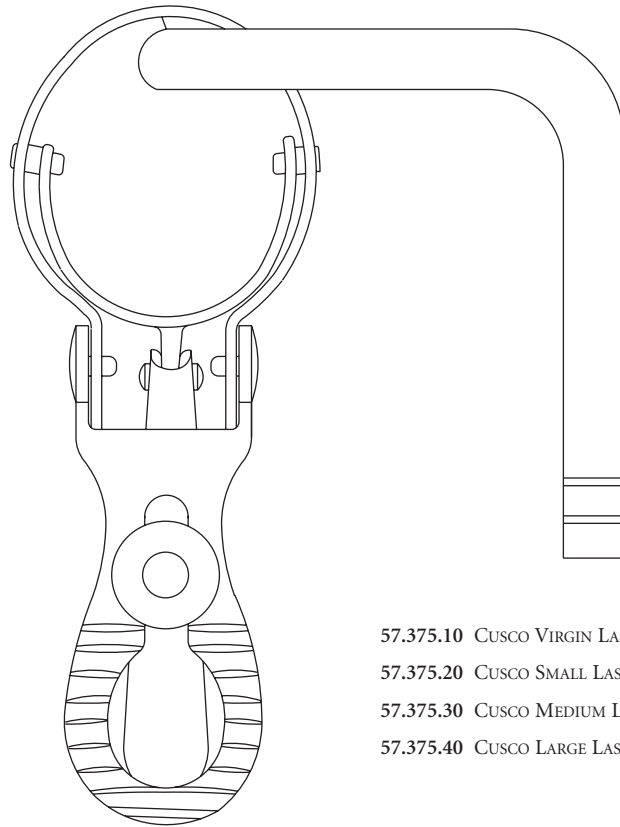
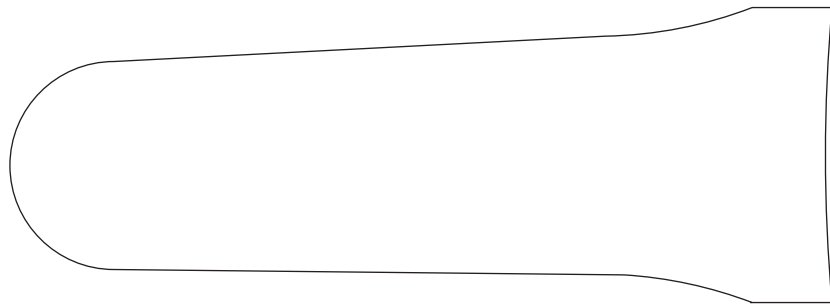

57.375.10 CUSCO VIRGIN LASER BLACK 15MM X 65MM

57.375.20 CUSCO SMALL LASER BLACK 25MM X 80MM

57.375.30 CUSCO MEDIUM LASER BLACK 30MM X 90MM

57.375.40 CUSCO LARGE LASER BLACK 35MM X 95MM



CUSCO

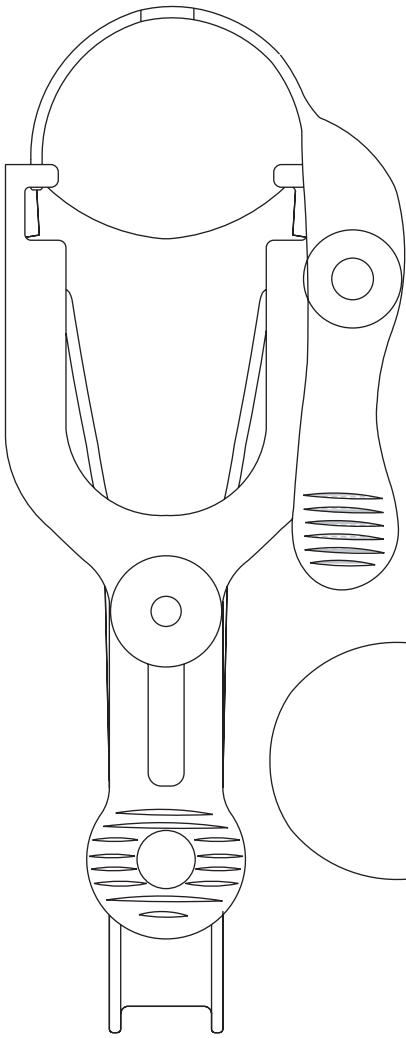

57.400.20 GRAVES (BREWER) SMALL 20MM X 75MM

57.400.30 GRAVES (BREWER) MEDIUM 35MM X 95MM

57.400.40 GRAVES (BREWER) LARGE 35MM X 115MM

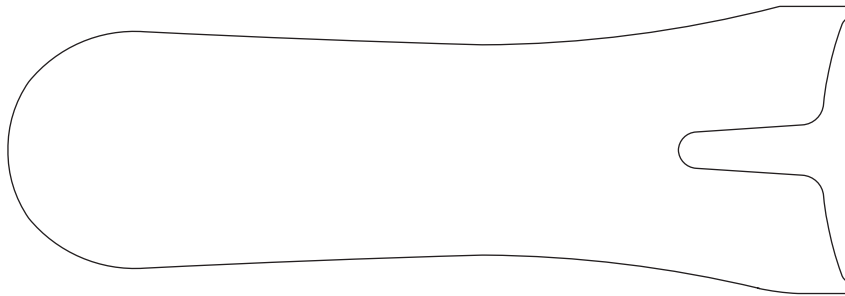

Both the Graves and Pederson speculums can be unscrewed from the screw in their handles and the upper blades raised vertically.

The speculum can also be used as single ended speculums, such as the Sims, by unscrewing the central screw and rotating one section 180°, for retrograde procedures.



GRAVES

SPECULUMS

Timesco also offers speculums for electro medical procedures; these are coated in our unique nylon insulation coating.

*The majority of the speculum, which are coated, are used in LETZ (Loop Excision Transitional Zone) procedures and are supplied with 'smoke extraction' tubes. Please see separate notes on nylon coated *BIC* items.*

Blue-coated items are for use in LETZ procedure only.

29
27
26
23
22
21
20
19
18
17
16
15
14
13
12
10
9
8
7
6
5
4
3
2



GRAVES

- 57.401.20 GRAVES SMALL 20MM X 75MM *BIC/ST*
- 57.401.30 GRAVES MEDIUM 35MM X 95MM *BIC/ST*
- 57.401.40 GRAVES LARGE 35MM X 115MM *BIC/ST*



GRAVES WIDE

- 57.403.30 GRAVES MEDIUM WIDE PATTERN 33MM X 105MM *BIC/ST*
- 57.403.40 GRAVES LARGE WIDE PATTERN 34MM X 115MM *BIC/ST*



GRAVES WIDE

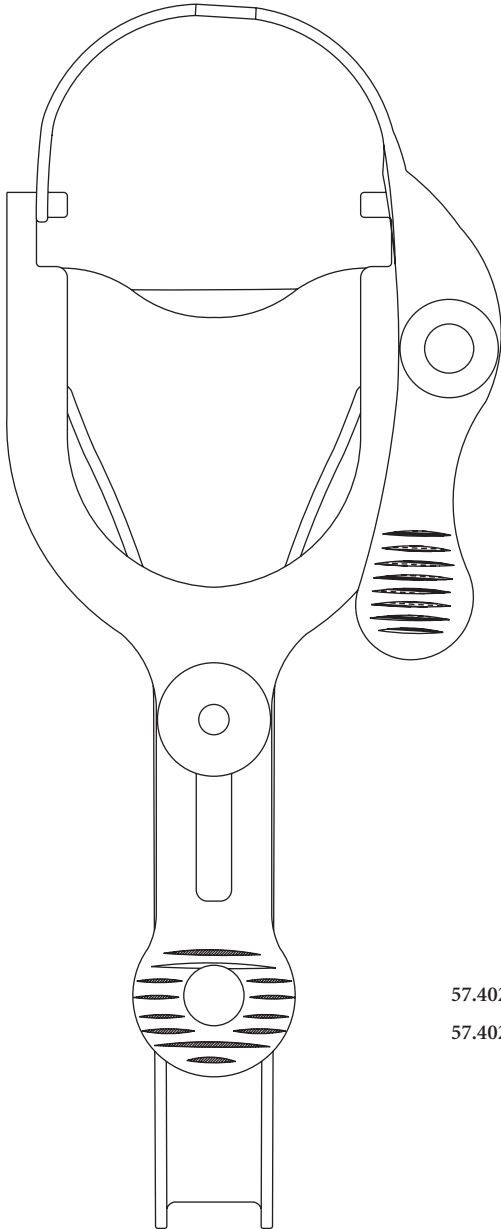

57.402.30 GRAVES MEDIUM WIDE PATTERN 33MM X 105MM

57.402.40 GRAVES LARGE WIDE PATTERN 34MM X 115MM

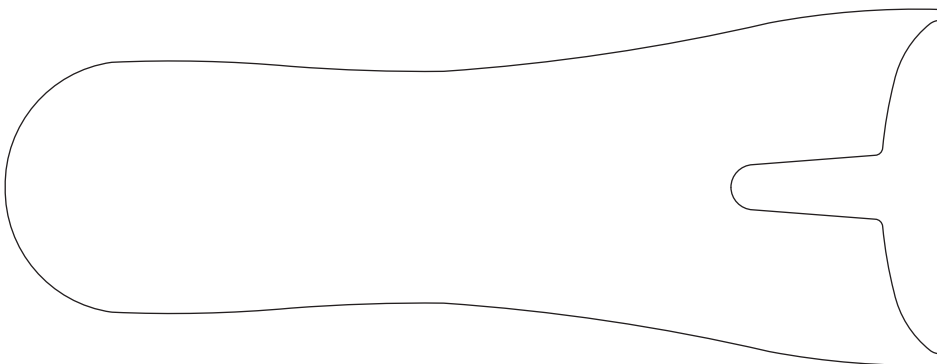

Graves 'Wide' pattern speculums have a larger opening at the back of the speculums allowing larger exposure and ease of insertion of instruments such as the standard and 3" opening Timesco lateral wall retractors.

SPECULUMS

Part of the sides of the upper blades in the left and right opening Weisman Graves speculums have been removed to allow greater visualisation of the left and right vaginal walls respectively.

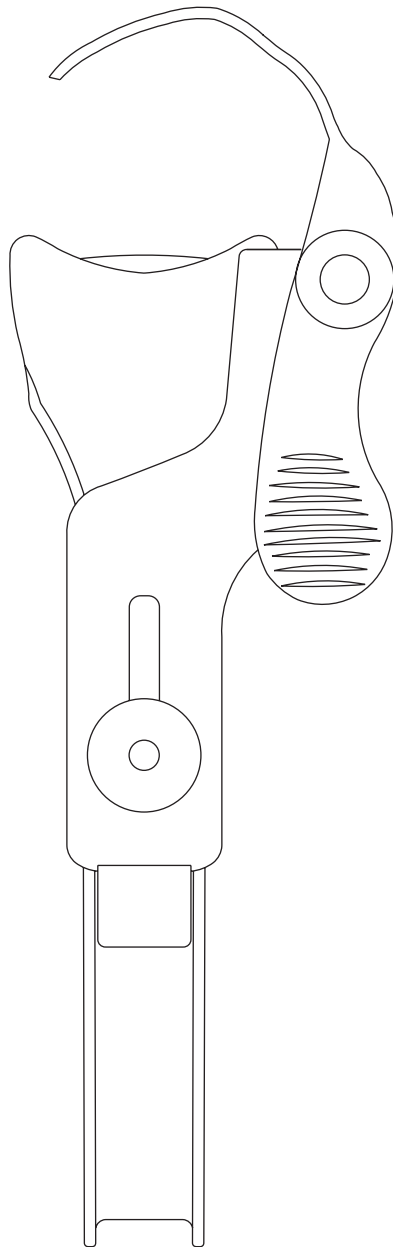
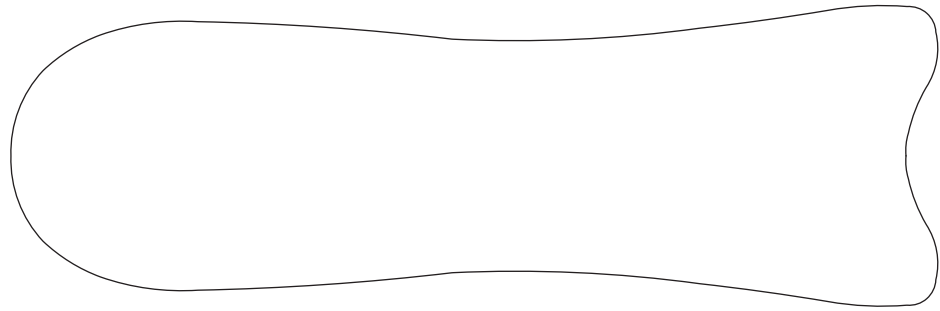

WEISMAN GRAVES

57.407.20 WEISMAN GRAVES LEFT OPEN 35MM X 115MM

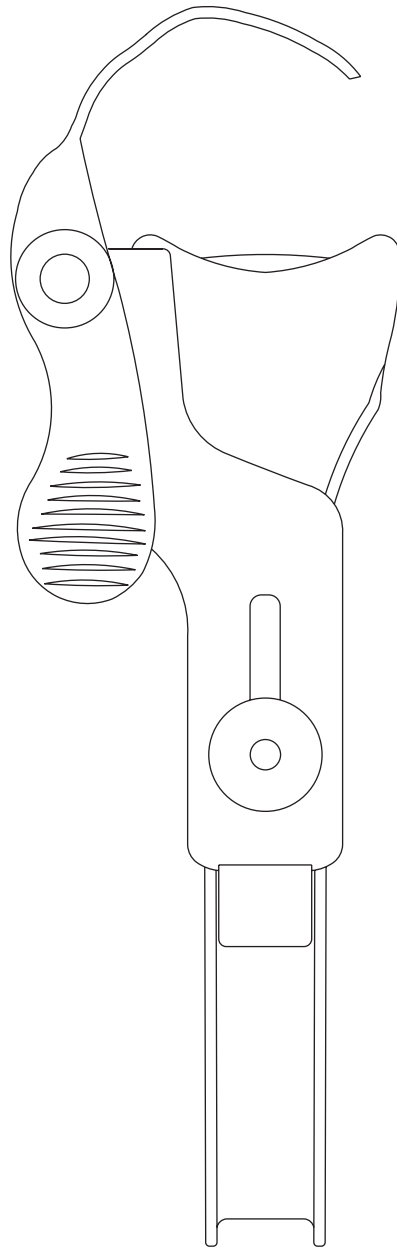
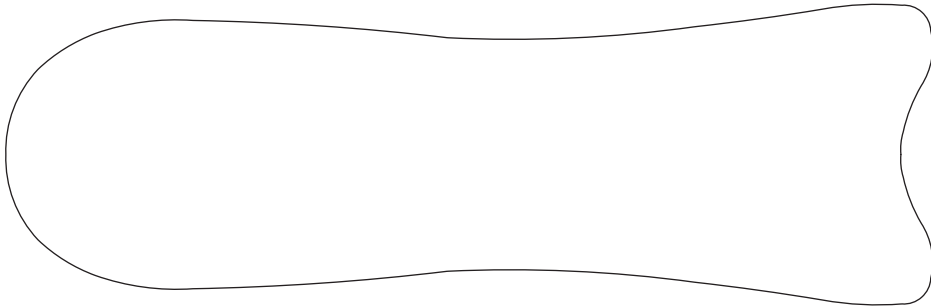

57.407.40 WEISMAN GRAVES RIGHT OPEN 35MM X 115MM

SPECULUMS

The Graves and Pederson speculums are also available with the disposable tube clip arrangement for the smoke extraction plastic tubes.



WEISMAN GRAVES

57.408.20 WEISMAN GRAVES LEFT OPEN 35MM X 115MM *BIC/ST*

57.408.40 WEISMAN GRAVES RIGHT OPEN 35MM X 115MM *BIC/ST*



PEDERSON

57.411.10 PEDERSON NARROW 17MM X 100MM *BIC/ST*

57.411.20 PEDERSON SMALL 13MM X 75MM *BIC/ST*

57.411.30 PEDERSON MEDIUM 22MM X 100MM *BIC/ST*

57.411.40 PEDERSON LARGE 25MM X 120MM *BIC/ST*

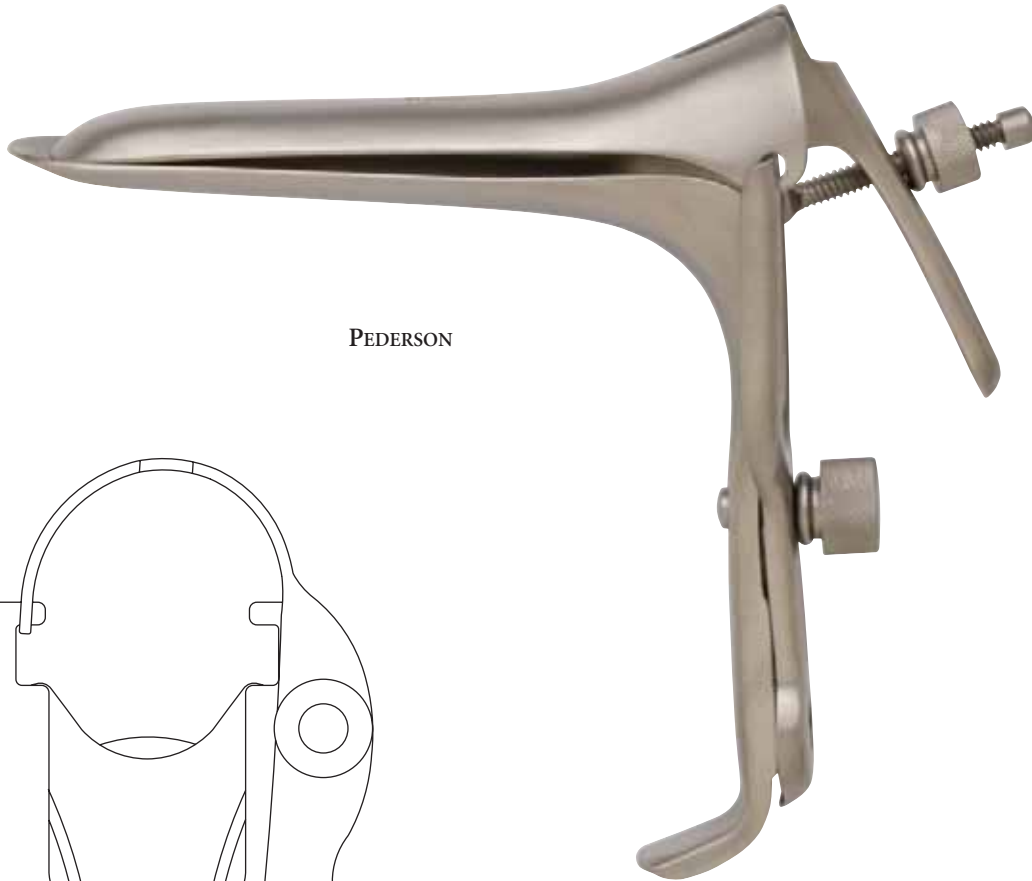

PEDERSON

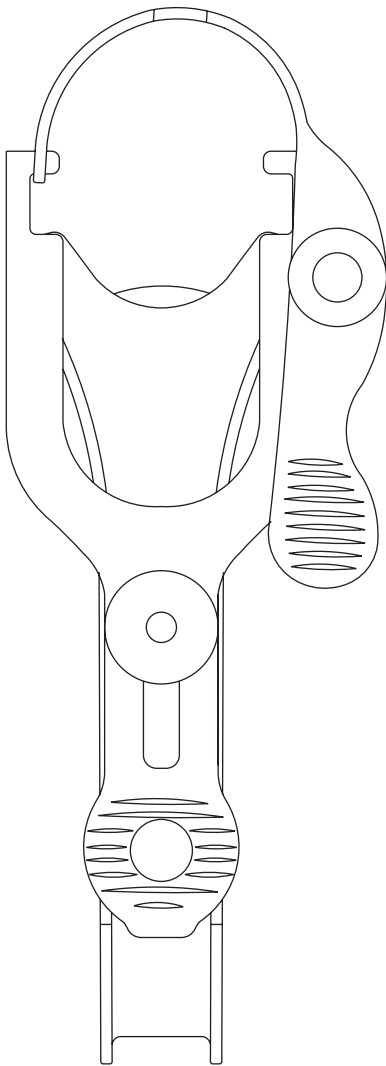

- 57.410.10 PEDERSON NARROW 17MM X 100MM
- 57.410.20 PEDERSON SMALL 13MM X 75MM
- 57.410.30 PEDERSON MEDIUM 22MM X 100MM
- 57.410.40 PEDERSON LARGE 25MM X 120MM

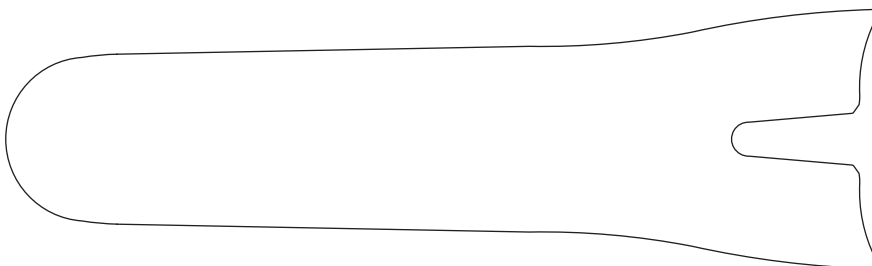

SPECULUMS

27
26
25
24
23
22
21
20
19
18
17
15
14
13
12
11
10
9
8
7
6
5
4
3
2

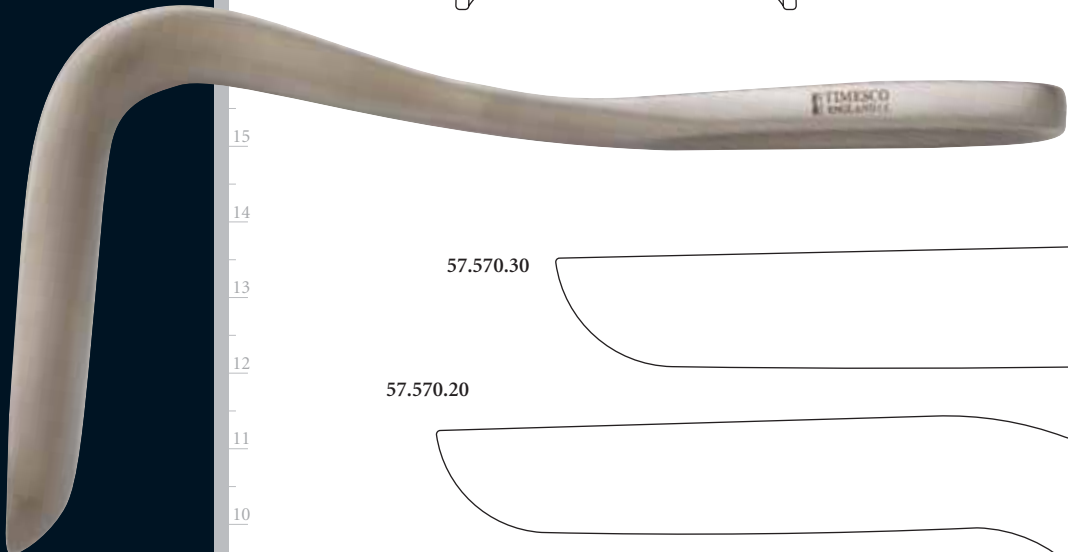
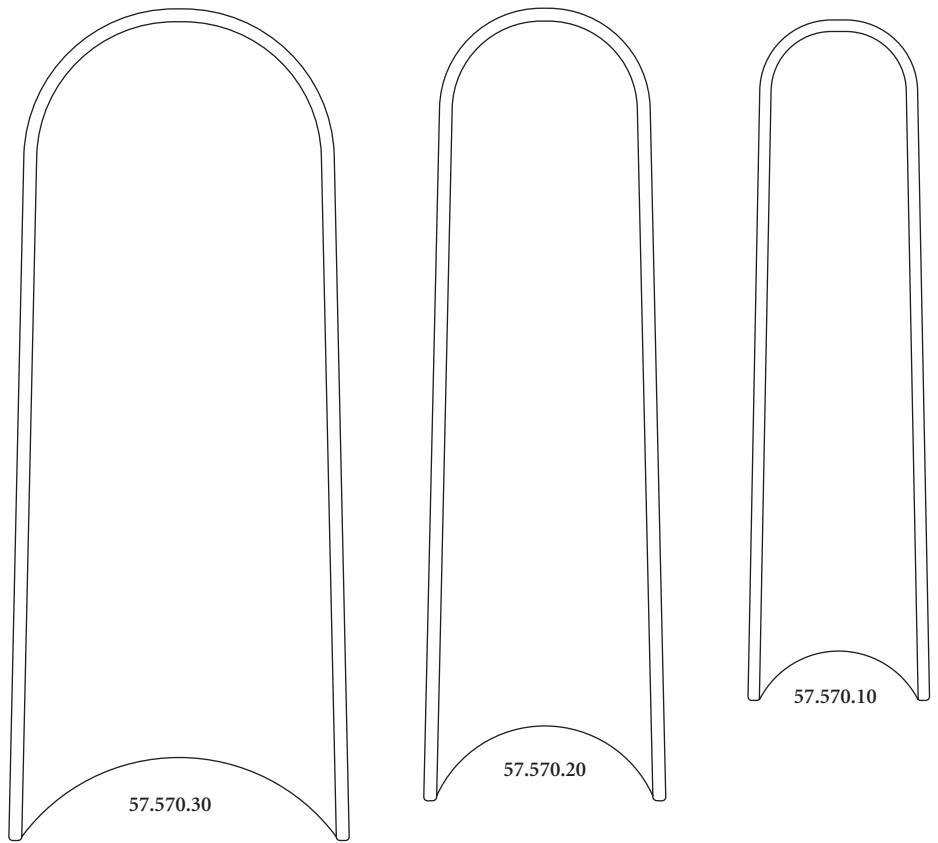

SIMS

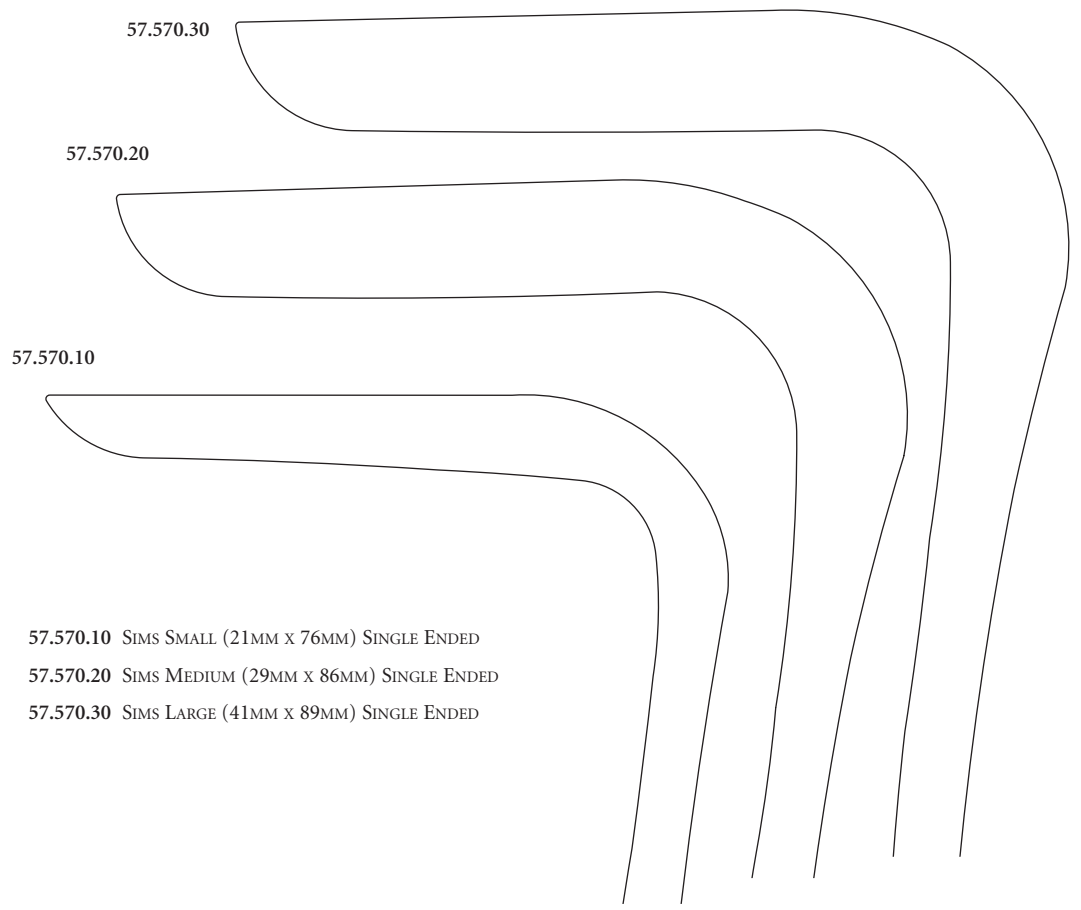

- 57.570.10 SIMS SMALL (21MM X 76MM) SINGLE ENDED
- 57.570.20 SIMS MEDIUM (29MM X 86MM) SINGLE ENDED
- 57.570.30 SIMS LARGE (41MM X 89MM) SINGLE ENDED



SIMS

- 57.572.10 SIMS SMALL (21MM X 76MM) SINGLE ENDED *BIC*
- 57.572.20 SIMS MEDIUM (29MM X 86MM) SINGLE ENDED *BIC*
- 57.572.30 SIMS LARGE (41MM X 89MM) SINGLE ENDED *BIC*



SIMS

- 57.578.20 SIMS SMALL DOUBLE ENDED (26MM X 70MM) (30MM X 75MM) *BIC*
- 57.578.30 SIMS MEDIUM DOUBLE ENDED (30MM X 75MM) (35MM X 80MM) *BIC*
- 57.578.40 SIMS LARGE DOUBLE ENDED (36MM X 80MM) (40MM X 90MM) *BIC*

SPECULUMS

57.575.20

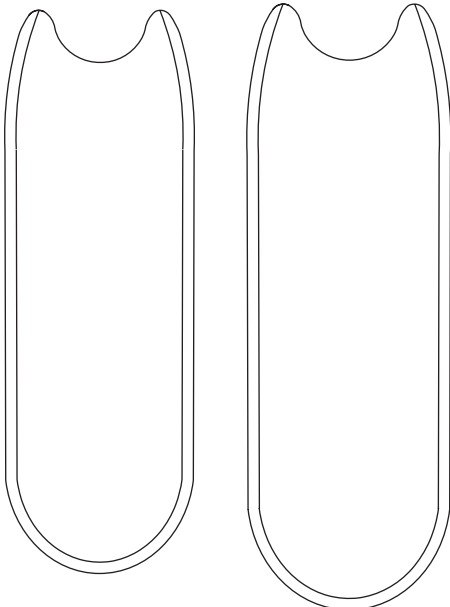

57.575.30

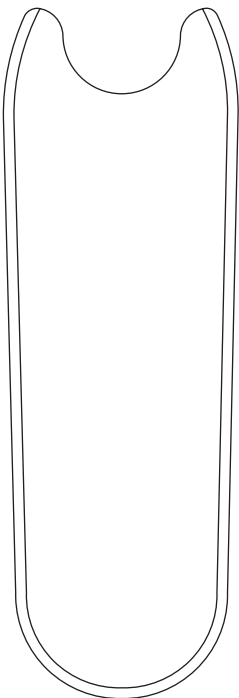

57.575.40



57.575.30

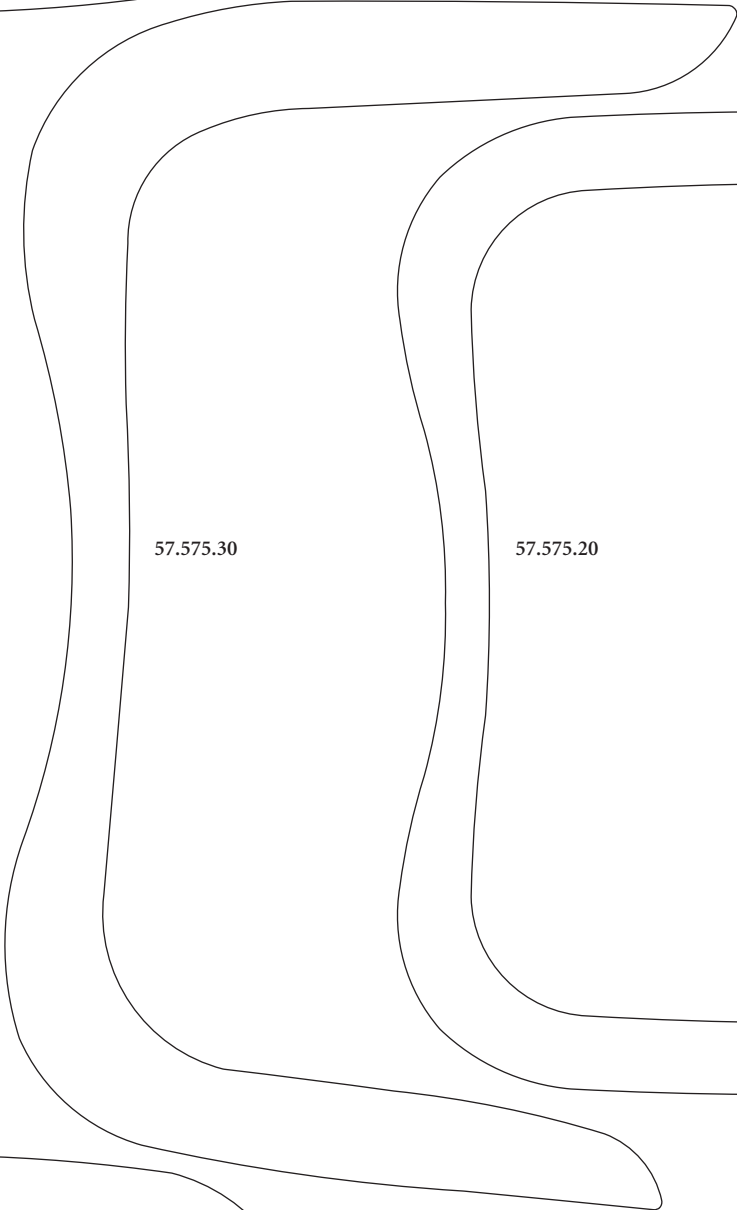

57.575.20

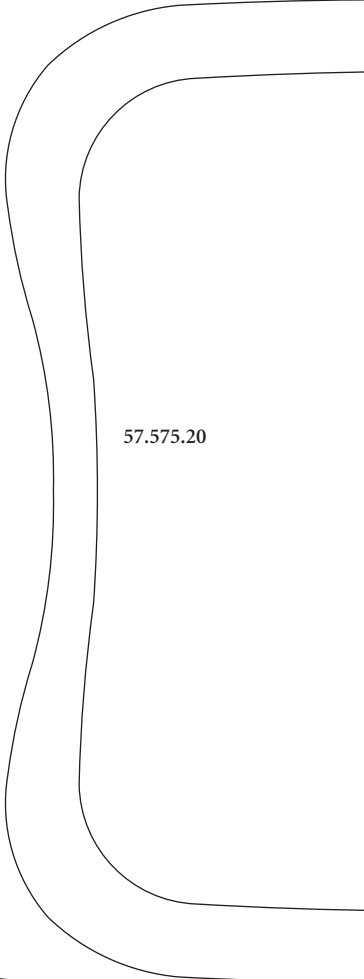

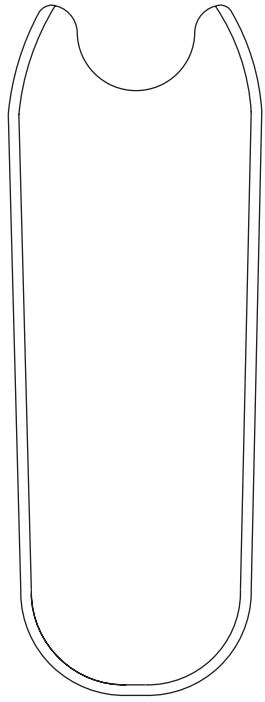

57.575.40

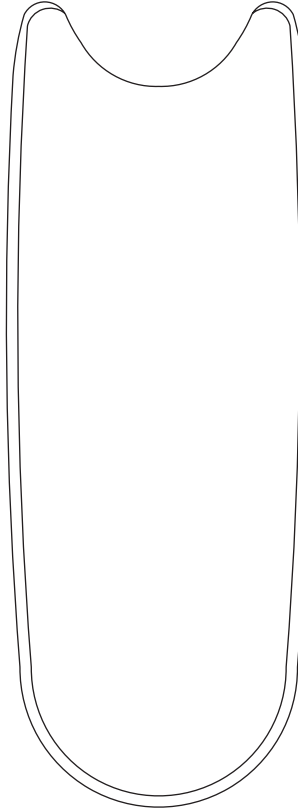
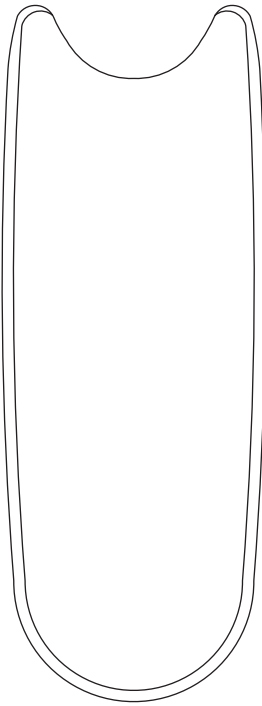

SIMS

- 57.575.20 SIMS SMALL DOUBLE ENDED (26MM X 70MM) (30MM X 75MM)
- 57.575.30 SIMS MEDIUM DOUBLE ENDED (30MM X 75MM) (35MM X 80MM)
- 57.575.40 SIMS LARGE DOUBLE ENDED (36MM X 80MM) (40MM X 90MM)



SPECULUMS

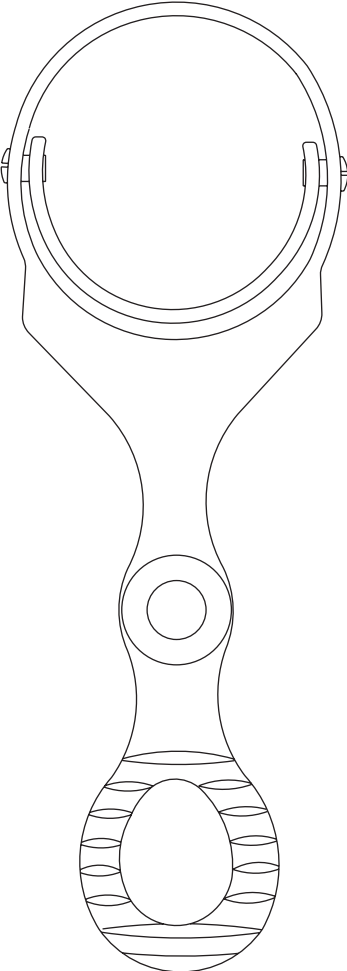
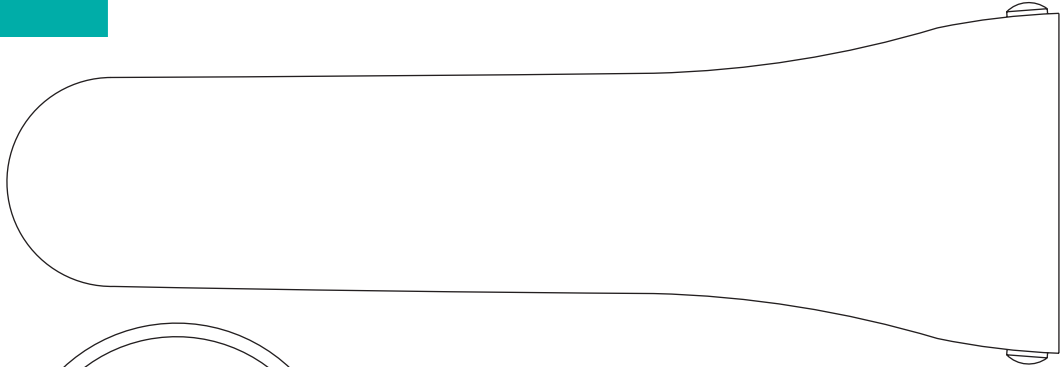

57.620.20 WINTERTON VAGINAL 23MM X 115MM



WINTERTON

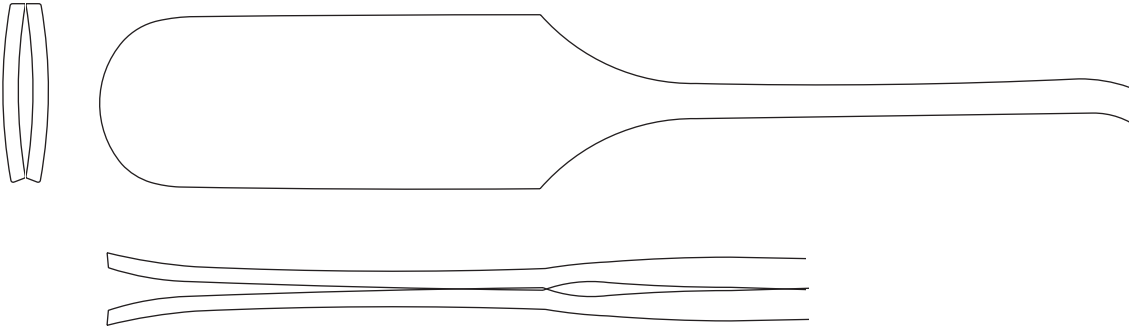

57.615.20S TIMESCO VAGINAL 9.75" (25CM)

Wall retraction up to maximum 2"



57.615.75S TIMESCO VAGINAL 9.75" (25CM) *BIC*

Wall retraction up to maximum 2"

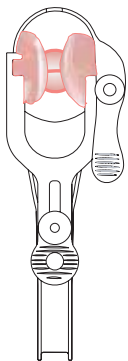

Restricted cervix exposure without Timesco lateral retractor being used.

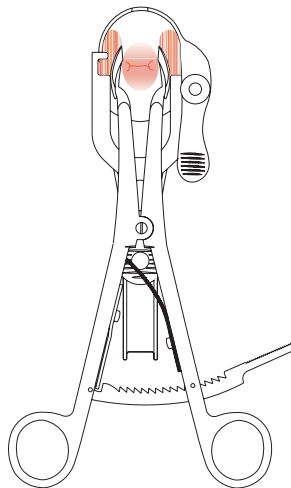

Full cervix exposure with Timesco lateral retractor.

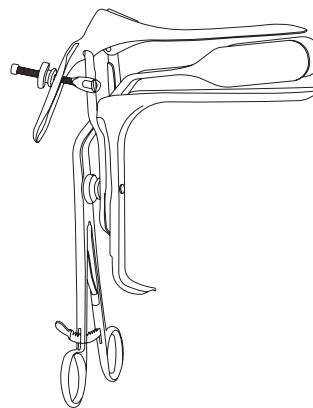

Timesco lateral retractor being used through the Graves speculum.

29
27
26
25
24
23
22
21
20
19
18
17
16
15
14
11
10
9
5
4
3
2
CM

LATERAL WALL RETRACTORS

For procedures where a clear visualisation is required for the cervix, eg. loop conisation, Biopsy procedures etc, which the standard speculums cannot provide, the Timesco lateral (wall) vaginal retractors are ideal. These are inserted after the introduction of the vaginal speculum, and opened, allowing the lateral side walls of the vagina being depressed out allowing an unobtrusive view of the cervix. Please see illustration.

An extra wide opening retractor, with 3" opening jaws is also available, which is best applied with a Graves 'wide' pattern speculum.

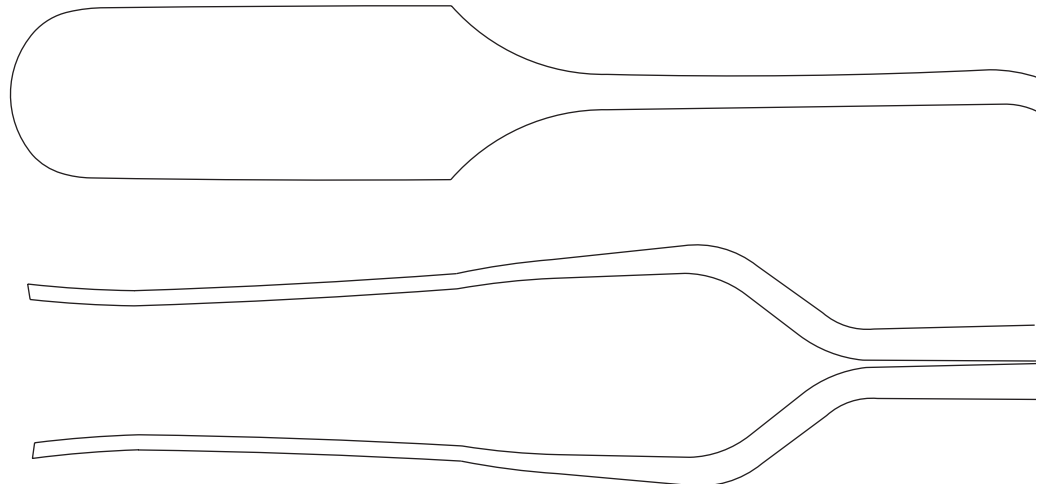
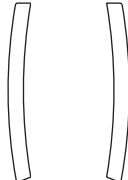

57.618.20S TIMESCO VAGINAL 9.75" 3" (25CM, 7.5CM) OPEN
Wall retraction up to maximum 3"

57.618.75S TIMESCO VAGINAL 9.75" 3" (25CM, 7.5CM) OPEN *BIC*
Wall retraction up to maximum 3"

BIOPSY FORCEPS

Timesco produce an extensive range of Biopsy forceps for cervical specimens. Many bite (Biopsy) sizes, shapes are available.

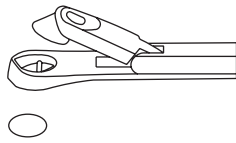

57.625.20S BURKE 8.5" (21.5CM) SHAFT

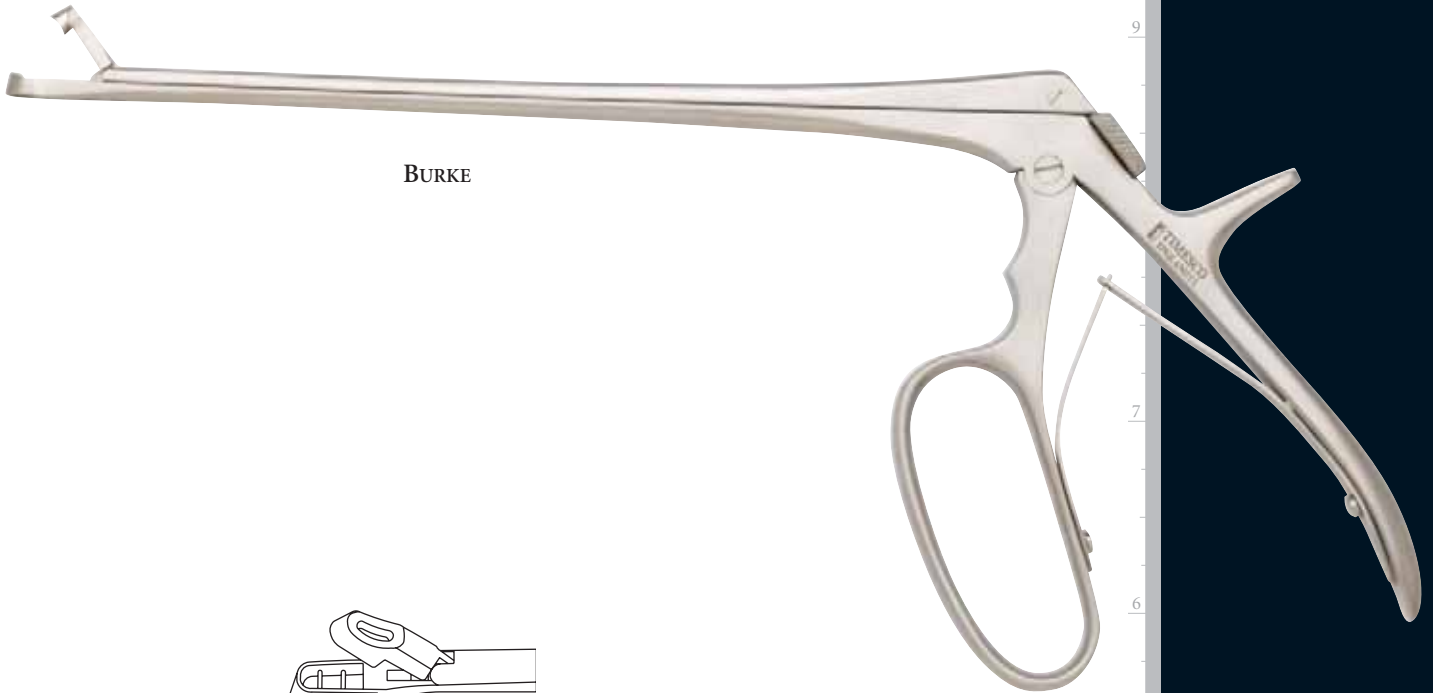

BURKE

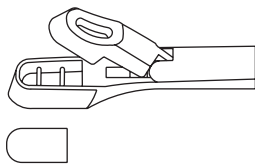

57.630.10 EPPENDORF 8" (20CM) SHAFT

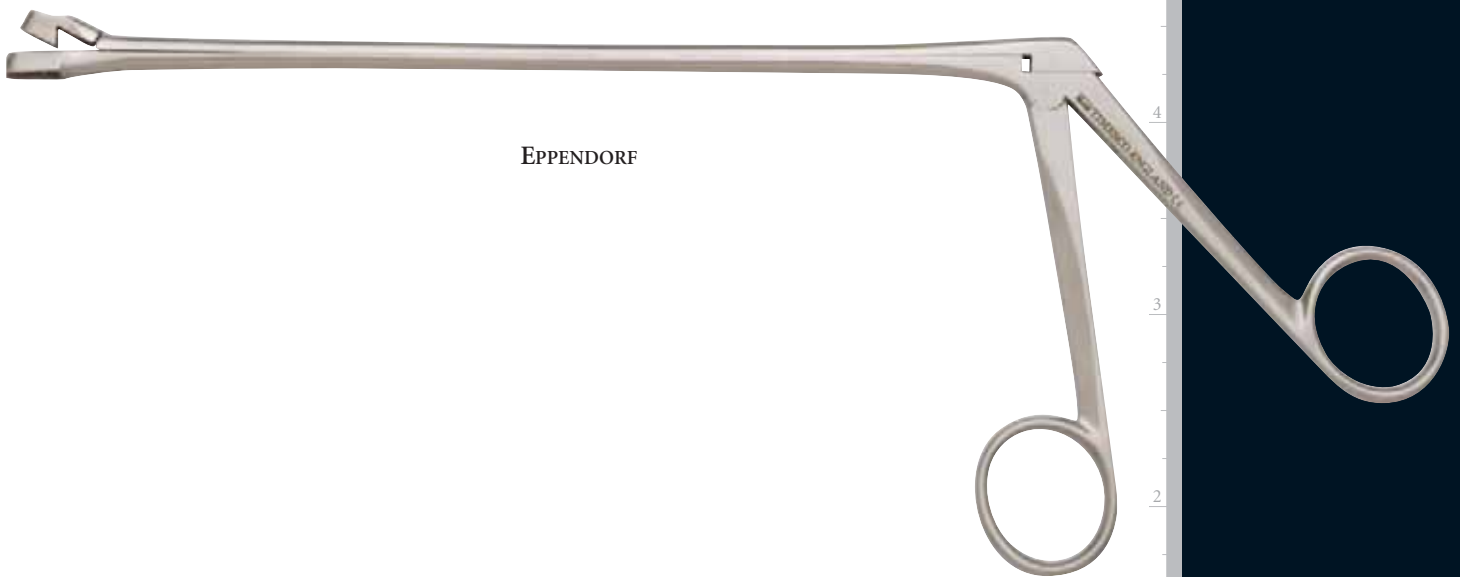

EPPENDORF

BIOPSY FORCEPS

The powerful crocodile action forceps such as Tischler, Burke, Kevorkian also have a special lock feature, which keeps the jaw closed after the Biopsy has been taken.

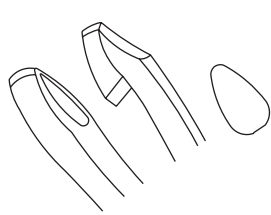

57.640.10 FAURE 8.25" (21.5CM)

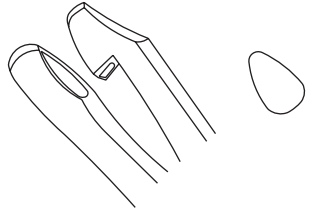

57.640.20 FAURE 9.5" (21.5CM)



FAURE

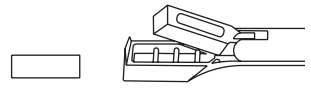

57.658.20S KEVORKIAN YOUNG 10" (25.5CM) SHAFT

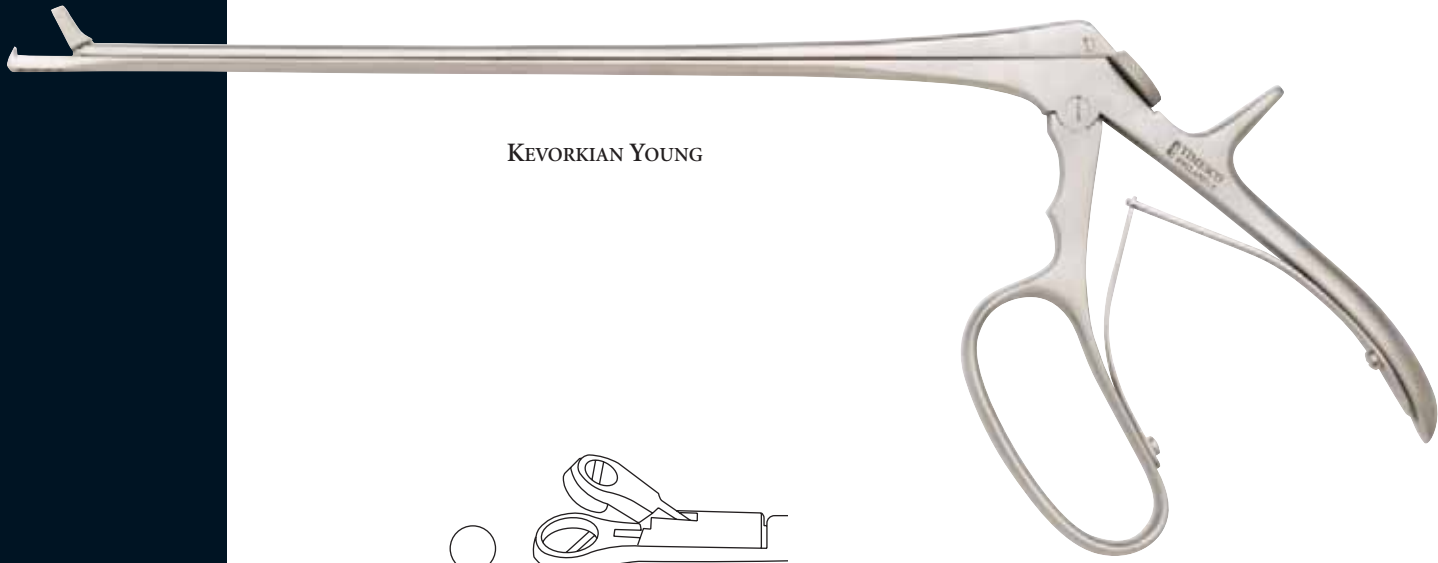

KEVORKIAN YOUNG

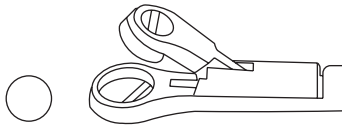

57.660.20 LEECH WILKINSON 8" (20CM) SHAFT ROUND

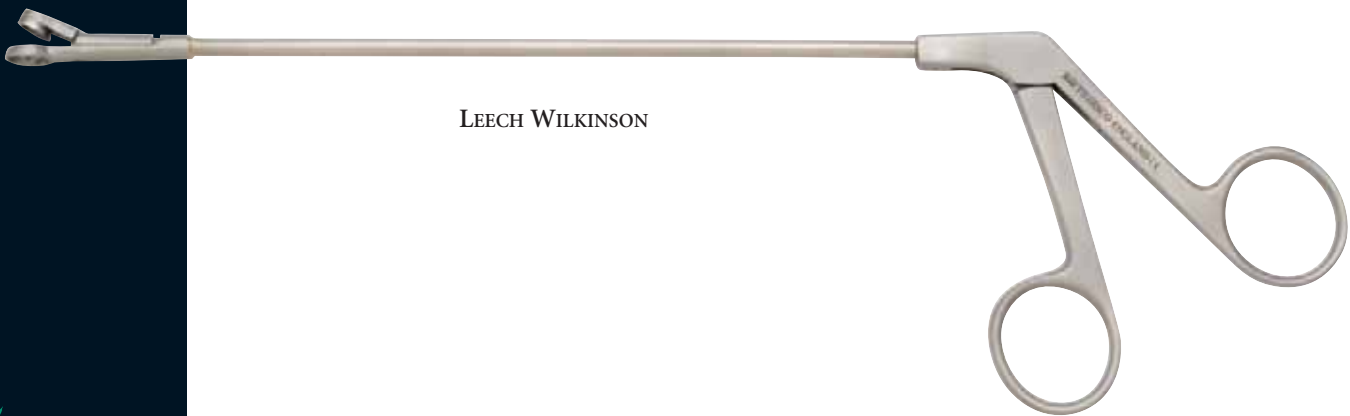

LEECH WILKINSON

All Timesco Biopsy forceps are made from specially hardened cutting jaws, which excise tissue with minimum hand fatigue.

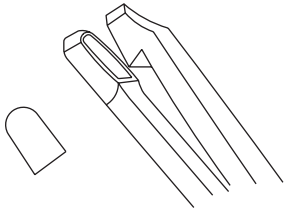

57.675.20 SCHUBERT 10.25" (20CM) BOX JOINT

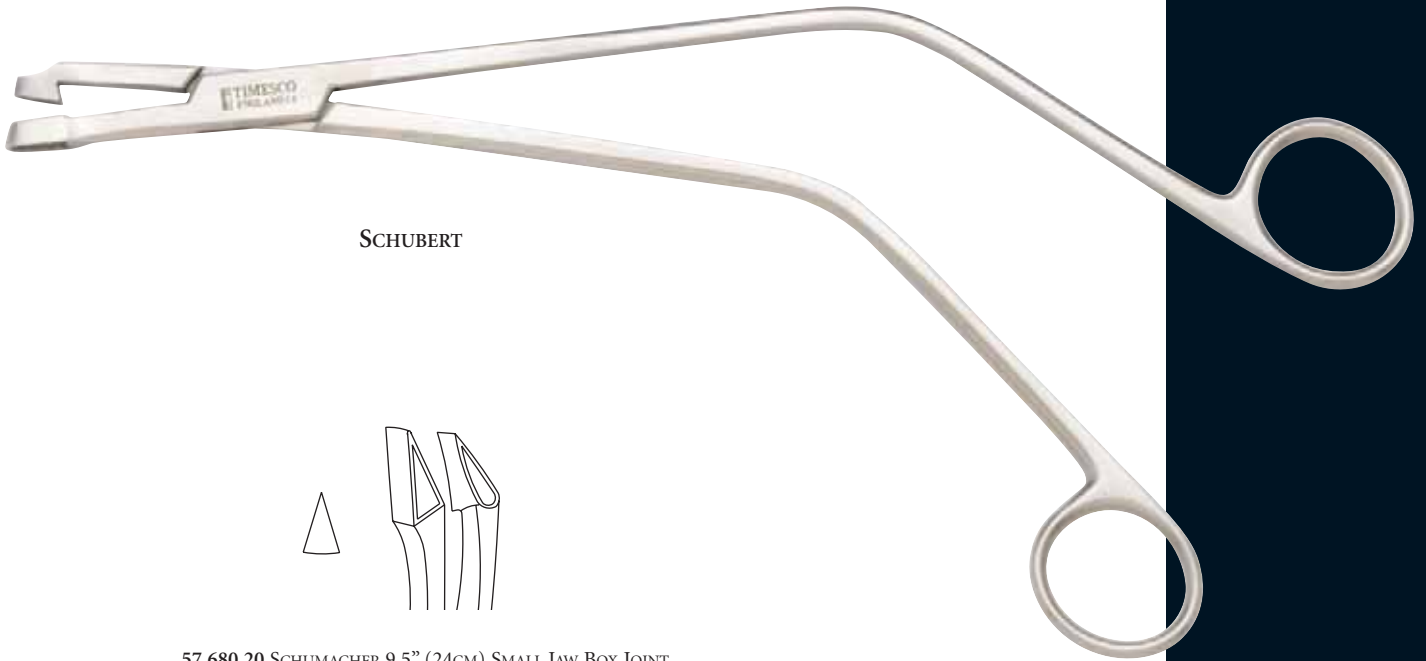

SCHUBERT

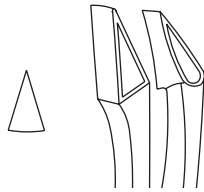

57.680.20 SCHUMACHER 9.5" (24CM) SMALL JAW BOX JOINT

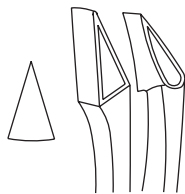

57.680.40 SCHUMACHER 9.5" (24CM) LARGE JAW BOX JOINT



SCHUMACHER

BIOPSY FORCEPS

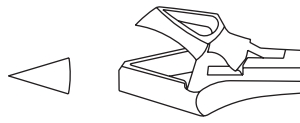

57.685.20 SCHUMACHER SMALL JAW 9.5" (24CM) SHAFT

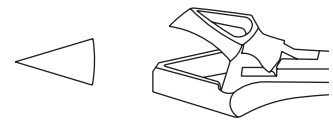

57.685.40 SCHUMACHER LARGE JAW 9.5" (24CM) SHAFT

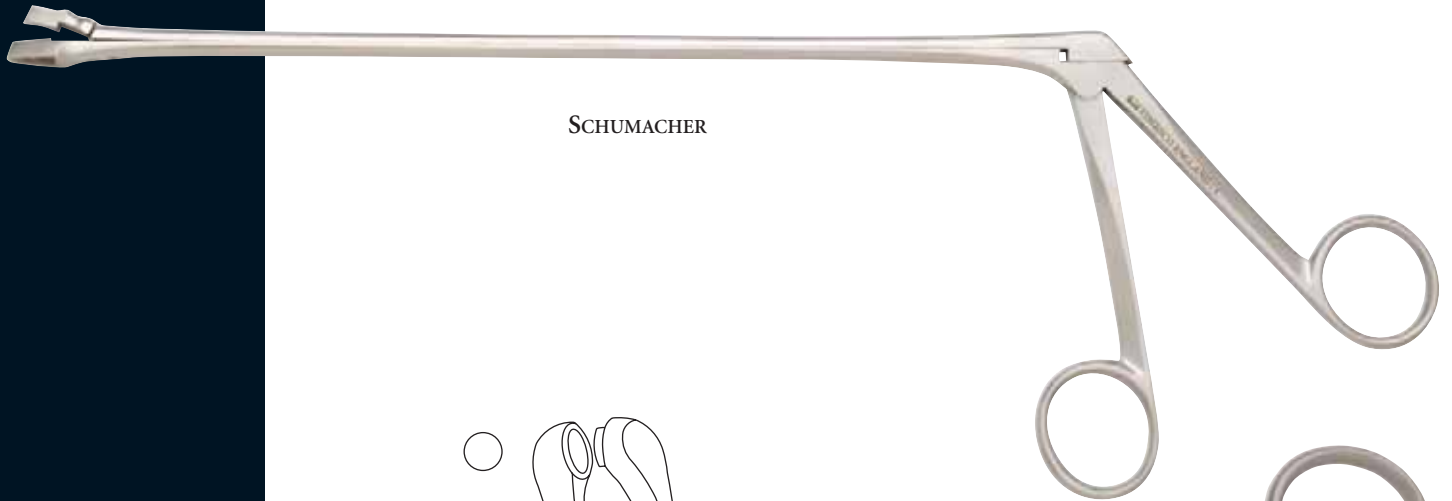

SCHUMACHER

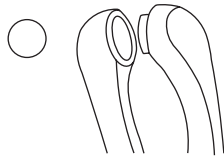

57.695.20 THOMS-GAYLOR 8.75" (22CM) BOX JOINT

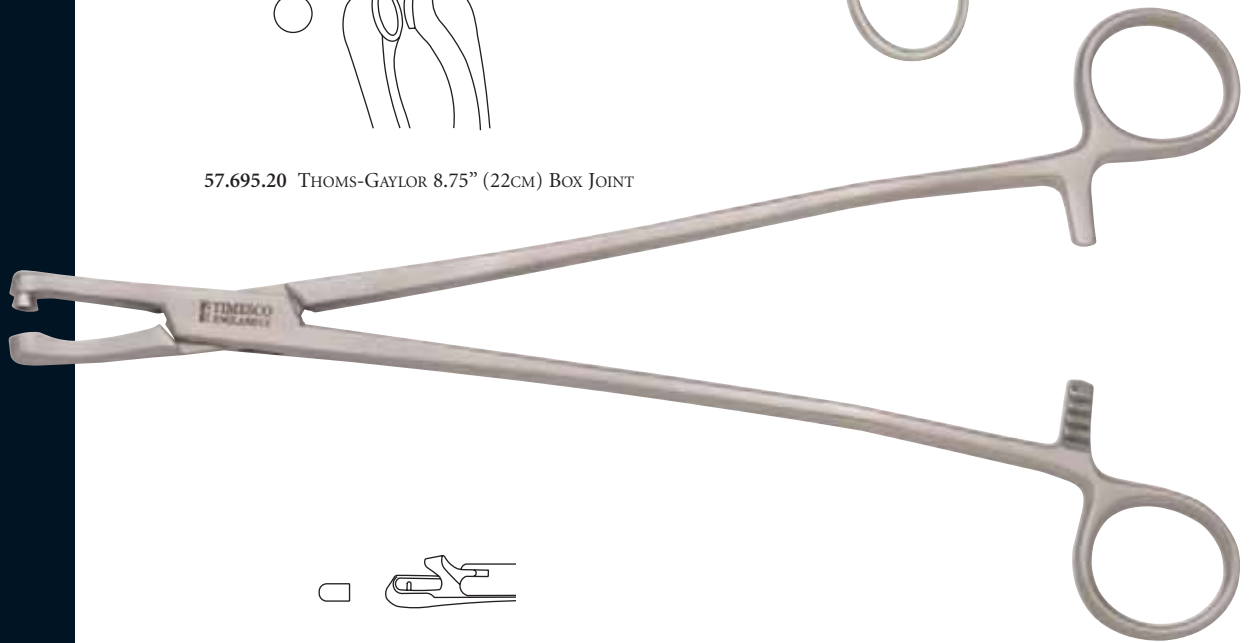

57.700.20S TISCHLER BABY 8.5" (21.5CM) SHAFT



TISCHLER BABY

TISCHLER

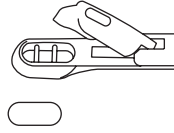
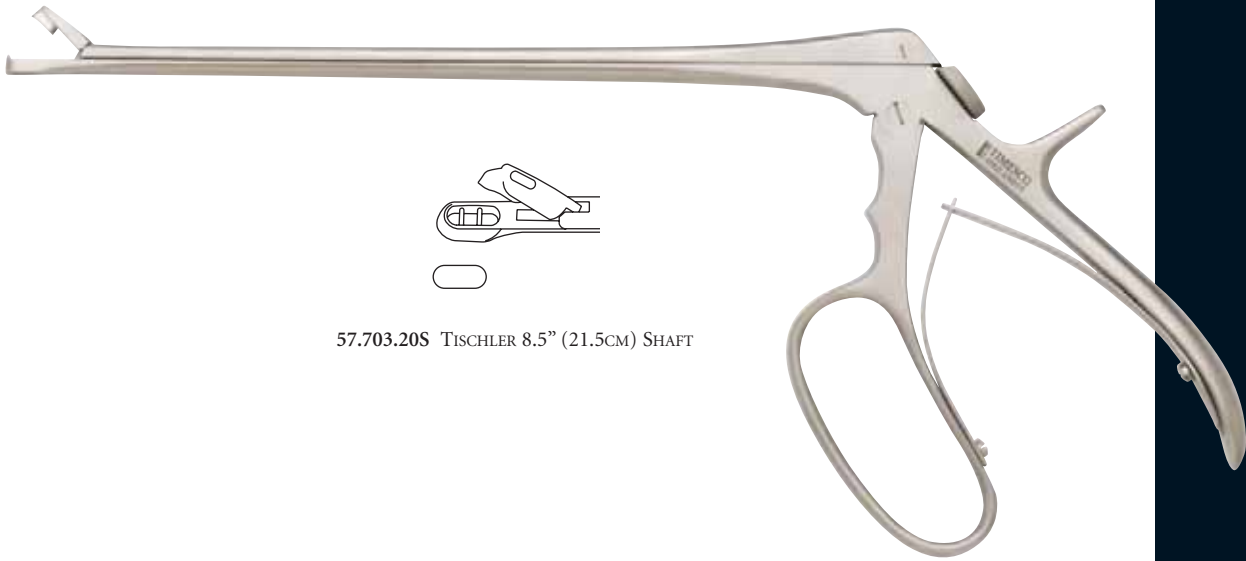

57.703.20S TISCHLER 8.5" (21.5CM) SHAFT

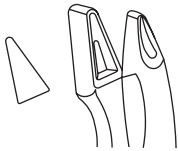

57.710.20 VAN DORAN 10.5" (27CM) BOX JOINT



VAN DORAN

WITTNER

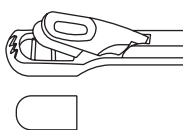
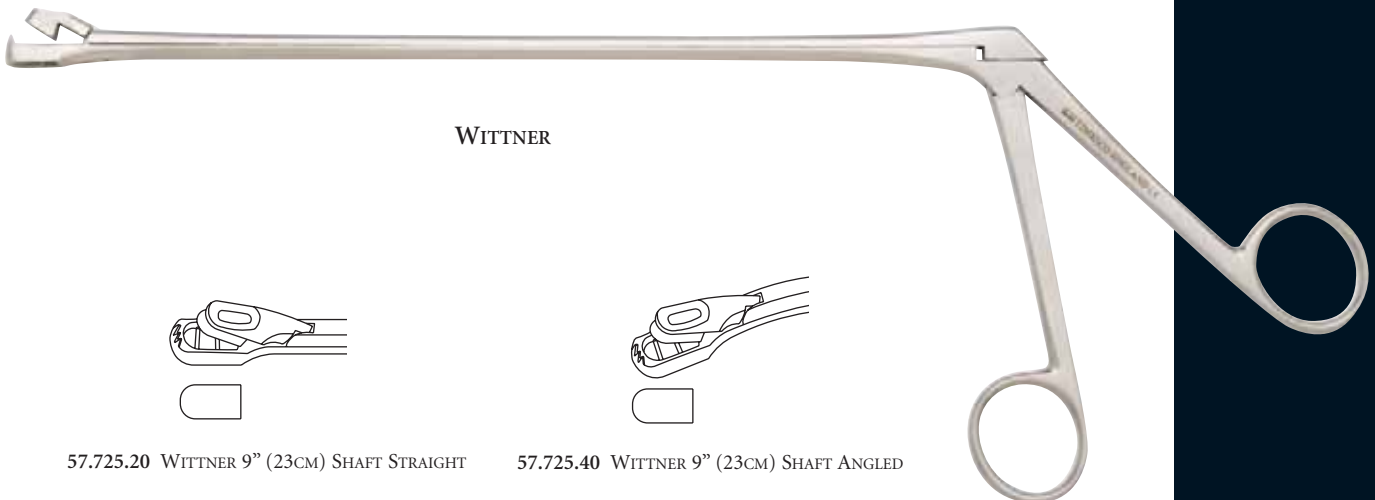

57.725.20 WITTNER 9" (23CM) SHAFT STRAIGHT

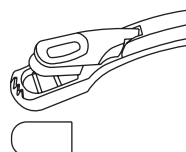

57.725.40 WITTNER 9" (23CM) SHAFT ANGLED

DILATORS

Dilator diameters
in MM.

0.5 ◦

1 ◦

2 ◦

3 ◦

4

5

6

7

8

9

10

11

12

13

14

15

16

17

18

19

20

21

22

23

24

25

26

27

Many varieties of Dilators are available. Timesco is only showing in this catalogue the most popular European and North American designs.

- 57.735.05 BONNEY-BARKER 7.25" (18.5CM) 3-4-5MM
- 57.735.10 BONNEY-BARKER 7.25" (18.5CM) 4-5-6MM
- 57.735.15 BONNEY-BARKER 7.25" (18.5CM) 5-6-7MM
- 57.735.20 BONNEY-BARKER 7.25" (18.5CM) 6-7-8MM
- 57.735.25 BONNEY-BARKER 7.25" (18.5CM) 7-8-9MM
- 57.735.30 BONNEY-BARKER 7.25" (18.5CM) 8-9-10MM
- 57.735.35 BONNEY-BARKER 7.25" (18.5CM) 9-10-11MM
- 57.735.40 BONNEY-BARKER 7.25" (18.5CM) 10-11-12MM
- 57.735.45 BONNEY-BARKER 7.25" (18.5CM) 11-12-13MM
- 57.735.50 BONNEY-BARKER 7.25" (18.5CM) 12-13-14MM
- 57.735.55 BONNEY-BARKER 7.25" (18.5CM) 13-14-15MM
- 57.735.60 BONNEY-BARKER 7.25" (18.5CM) 14-15-16MM
- 57.735.65 BONNEY-BARKER 7.25" (18.5CM) 15-16-17MM
- 57.735.70 BONNEY-BARKER 7.25" (18.5CM) 16-17-18MM
- 57.735.75 BONNEY-BARKER 7.25" (18.5CM) 17-18-19MM
- 57.735.80 BONNEY-BARKER 7.25" (18.5CM) 18-19-20MM
- 57.735.90 BONNEY-BARKER SET-16 7.5" (19MM)
- 57.735.95 BONNEY-BARKER CANVAS ROLL



BONNEY-BARKER

- 57.740.10 HANK DOUBLE ENDED 10.5" (27CM) 9/10MM
- 57.740.20 HANK DOUBLE ENDED 10.5" (27CM) 11/12MM
- 57.740.30 HANK DOUBLE ENDED 10.5" (27CM) 13/14MM
- 57.740.40 HANK DOUBLE ENDED 10.5" (27CM) 15/16MM
- 57.740.50 HANK DOUBLE ENDED 10.5" (27CM) 17/18MM
- 57.740.60 HANK DOUBLE ENDED 10.5" (27CM) 19/20MM
- 57.740.90 HANK SET 6 D/E 9/10-19/20MM



HANK

All Timesco dilators are made in super smooth finish, exacting curvatures, which allow easier insertion to dilate the cervix. The Hegar dilators, which are now by far the most popular pattern, especially the double-ended pattern, are also available in special 1/2 sizes on request.

Wherever available all dilators sets are supplied in canvas/rexin wraps.

- 57.760.10 HAWKIN AMBLER 6.75" (17CM) 3-6MM
- 57.760.15 HAWKIN AMBLER 6.75" (17CM) 4-7MM
- 57.760.20 HAWKIN AMBLER 6.75" (17CM) 5-8MM
- 57.760.25 HAWKIN AMBLER 6.75" (17CM) 6-9MM
- 57.760.30 HAWKIN AMBLER 6.75" (17CM) 7-10MM
- 57.760.35 HAWKIN AMBLER 6.75" (17CM) 8-11MM
- 57.760.40 HAWKIN AMBLER 6.75" (17CM) 9-12MM
- 57.760.45 HAWKIN AMBLER 6.75" (17CM) 10-13MM
- 57.760.50 HAWKIN AMBLER 6.75" (17CM) 11-14MM
- 57.760.55 HAWKIN AMBLER 6.75" (17CM) 12-15MM
- 57.760.60 HAWKIN AMBLER 6.75" (17CM) 13-16MM
- 57.760.65 HAWKIN AMBLER 6.75" (17CM) 14-17MM
- 57.760.70 HAWKIN AMBLER 6.75" (17CM) 15-18MM
- 57.760.75 HAWKIN AMBLER 6.75" (17CM) 16-19MM
- 57.760.80 HAWKIN AMBLER 6.75" (17CM) 17-20MM
- 57.760.85 HAWKIN AMBLER 6.75" (17CM) 18-21MM
- 57.760.90 HAWKIN AMBLER SET OF 16, 3/6-18/21MM
- 57.760.95 HAWKIN AMBLER CANVAS ROLL ONLY



HAWKIN AMBLER

- | | |
|--|--|
| 57.770.05 HEGAR SINGLE ENDED 7.25" (18.5CM) 2MM | 57.770.40 HEGAR SINGLE ENDED 7.25" (18.5CM) 16MM |
| 57.770.08 HEGAR SINGLE ENDED 7.25" (18.5CM) 3MM | 57.770.42 HEGAR SINGLE ENDED 7.25" (18.5CM) 17MM |
| 57.770.10 HEGAR SINGLE ENDED 7.25" (18.5CM) 4MM | 57.770.45 HEGAR SINGLE ENDED 7.25" (18.5CM) 18MM |
| 57.770.12 HEGAR SINGLE ENDED 7.25" (18.5CM) 5MM | 57.770.48 HEGAR SINGLE ENDED 7.25" (18.5CM) 19MM |
| 57.770.15 HEGAR SINGLE ENDED 7.25" (18.5CM) 6MM | 57.770.50 HEGAR SINGLE ENDED 7.25" (18.5CM) 20MM |
| 57.770.18 HEGAR SINGLE ENDED 7.25" (18.5CM) 7MM | 57.770.52 HEGAR SINGLE ENDED 7.25" (18.5CM) 21MM |
| 57.770.20 HEGAR SINGLE ENDED 7.25" (18.5CM) 8MM | 57.770.55 HEGAR SINGLE ENDED 7.25" (18.5CM) 22MM |
| 57.770.22 HEGAR SINGLE ENDED 7.25" (18.5CM) 9MM | 57.770.58 HEGAR SINGLE ENDED 7.25" (18.5CM) 23MM |
| 57.770.25 HEGAR SINGLE ENDED 7.25" (18.5CM) 10MM | 57.770.60 HEGAR SINGLE ENDED 7.25" (18.5CM) 24MM |
| 57.770.28 HEGAR SINGLE ENDED 7.25" (18.5CM) 11MM | 57.770.62 HEGAR SINGLE ENDED 7.25" (18.5CM) 25MM |
| 57.770.30 HEGAR SINGLE ENDED 7.25" (18.5CM) 12MM | 57.770.65 HEGAR SINGLE ENDED 7.25" (18.5CM) 26MM |
| 57.770.32 HEGAR SINGLE ENDED 7.25" (18.5CM) 13MM | 57.770.90 HEGAR SET OF 12 S/E 3-14MM |
| 57.770.35 HEGAR SINGLE ENDED 7.25" (18.5CM) 14MM | 57.770.96 HEGAR SET 12 S/E CANVAS ONLY |
| 57.770.38 HEGAR SINGLE ENDED 7.25" (18.5CM) 15MM | |



HEGAR

The majority of dilators have fixed sizes along their length, some however, eg. 'Bonney Barker' are tapered, with a smaller size at the tip, gradually getting bigger at the base. These tapering dilators allow cervical dilations to be done (eg. three steps) with minimal use of individual dilators.

18

19

20

21

22

23

24

25

26

Please refer to the back of the publication for MM/FG/EG comparison chart.

DILATORS

As an ongoing process, all dilators are being made from stainless steel, some like the Hawkin Amblers are still supplied in electroplated versions. All dilators are available in set configurations. We have listed the most popular set combinations.

- 57.790.05 HEGAR DOUBLE ENDED 8" (20CM) 1/2MM
- 57.790.08 HEGAR DOUBLE ENDED 8" (20CM) 3/4MM
- 57.790.10 HEGAR DOUBLE ENDED 8" (20CM) 5/6MM
- 57.790.12 HEGAR DOUBLE ENDED 8" (20CM) 7/8MM
- 57.790.15 HEGAR DOUBLE ENDED 8" (20CM) 9/10MM
- 57.790.18 HEGAR DOUBLE ENDED 8" (20CM) 11/12MM
- 57.790.20 HEGAR DOUBLE ENDED 8" (20CM) 13/14MM
- 57.790.22 HEGAR DOUBLE ENDED 8" (20CM) 15/16MM
- 57.790.25 HEGAR DOUBLE ENDED 8" (20CM) 17/18MM
- 57.790.30 HEGAR DOUBLE ENDED 8" (20CM) 19/20MM
- 57.790.32 HEGAR DOUBLE ENDED 8" (20CM) 21/22MM
- 57.790.35 HEGAR DOUBLE ENDED 8" (20CM) 23/24MM
- 57.790.38 HEGAR DOUBLE ENDED 8" (20CM) 25/26MM
- 57.790.60 HEGAR SET 8 DOUBLE ENDED 3/4MM-17/18MM
- 57.790.70 HEGAR SET 12 DOUBLE ENDED 1/2MM-23/24MM
- 57.790.90 HEGAR SET 8 DOUBLE ENDED CANVAS ONLY
- 57.790.94 HEGAR SET 12 DOUBLE ENDED CANVAS ONLY



HEGAR

- 57.800.05 PRATT DOUBLE ENDED 11.5" (29CM) 13/15 FG
- 57.800.10 PRATT DOUBLE ENDED 11.5" (29CM) 17/19 FG
- 57.800.15 PRATT DOUBLE ENDED 11.5" (29CM) 21/23 FG
- 57.800.20 PRATT DOUBLE ENDED 11.5" (29CM) 25/27 FG
- 57.800.25 PRATT DOUBLE ENDED 11.5" (29CM) 29/31 FG
- 57.800.30 PRATT DOUBLE ENDED 11.5" (29CM) 33/35 FG
- 57.800.35 PRATT DOUBLE ENDED 11.5" (29CM) 37/39 FG
- 57.800.40 PRATT DOUBLE ENDED 11.5" (29CM) 41/43 FG
- 57.800.80 PRATT SET 8 DOUBLE ENDED 13/15-41/43 FG



PRATT

ENDOCERVICAL SPECULUMS

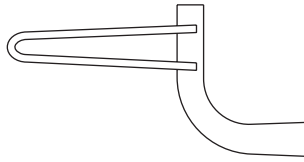

57.815.40S KOGAN 9.5" (24CM) CALIBRATED, WITH LOCK

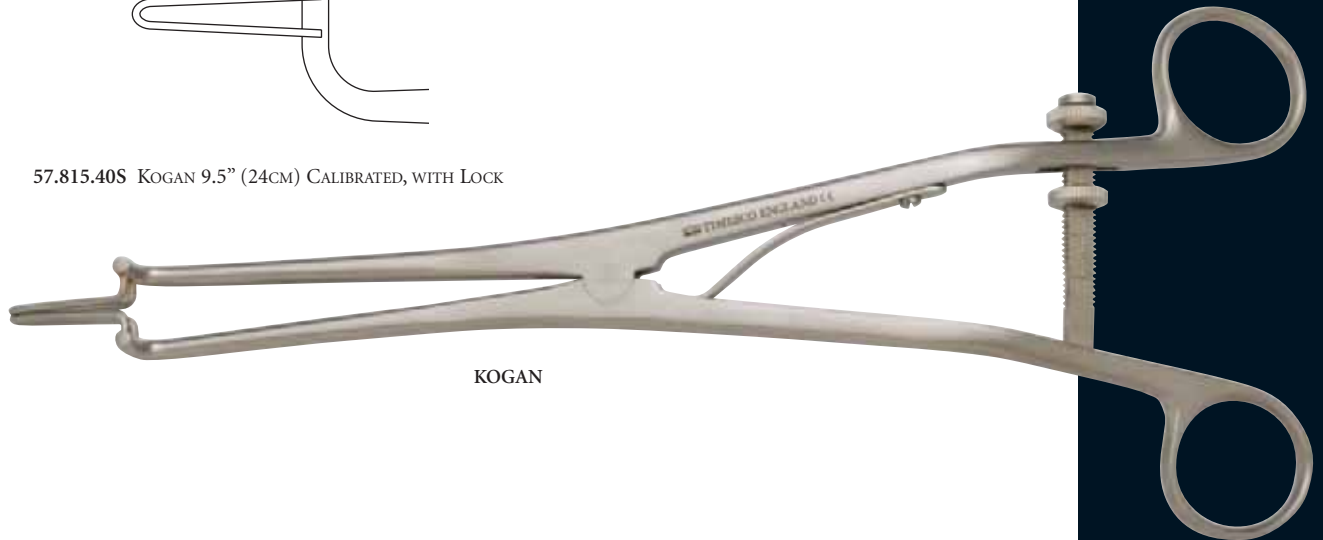

KOGAN

The Timesco Kogan Endocervical speculum has narrow wire blades, 4mm, which once introduced are opened gradually allowing gentle dilation of the cervical canal. The speculum is calibrated to control the dilation and avoid trauma.

TENACULUM/VULSELLUM FORCEPS



57.845.10S ATRAUMA STRAIGHT 9" (23CM) JAW 1/8"

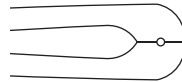

57.845.20S ATRAUMA STRAIGHT 9" (23CM) JAW 1/4"

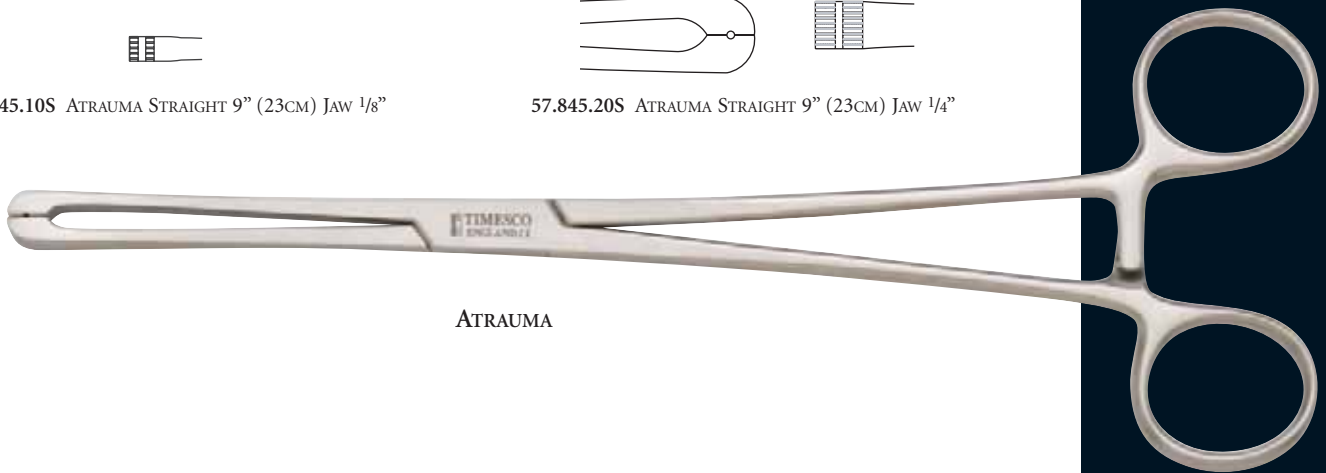
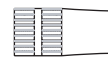

ATRAUMA

57.855.40 TIMESCO ATRAUMA 11.5" (29CM) 1/4" (0.5CM) JAW + SOUND



TIMESCO ATRAUMA

The Timesco Atrauma forceps feature a double row of longitudinally serrated, non-traumatic jaws which hold the cervix without crushing, tearing or slipping.

TENACULUM/VULSELLUM FORCEPS



57.855.50 TIMESCO CERVICAL DISSECTING FORCEP 9" (23CM) 1 x 12TH *BIC*



CERVICAL

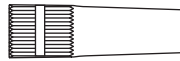

57.856.40 TIMESCO ATRAUMA VULSELLUM 11.5" (29CM) 1/4" (0.5CM) + SOUND *BIC*

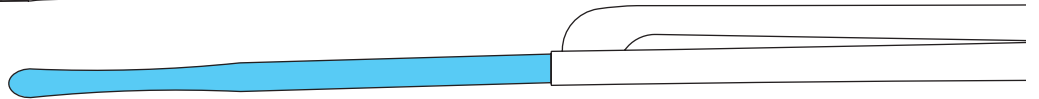

ATRAUMA



57.859.10 BIERER VULSELLUM TENACULUM FORCEP ANGLED 9.5" (24CM) BOX JOINT



BIERER

The Timesco Luer and Atrauma forceps are available with a 2-1/2" long uterine sound welded to one of the jaws. This allows one of the jaws to grip the cervix whilst the other jaw with sound manipulates the uterus. A rubber 'acorn', see Cat No: 58.685.10, can also be used at the base of the uterine sound to add traction. These forceps are also available with *BIC* coating and are ideal for laparoscopic procedures.

This is a popular North American style Tenaculum which due to its angled shanks allows clear unobstructed view of the cervix.

TENACULUM/VULSELLUM FORCEPS

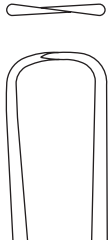

57.860.10 BRAUN VULSELLUM FORCEP 10" (25.5CM) 1 X 1TH BOX JOINT

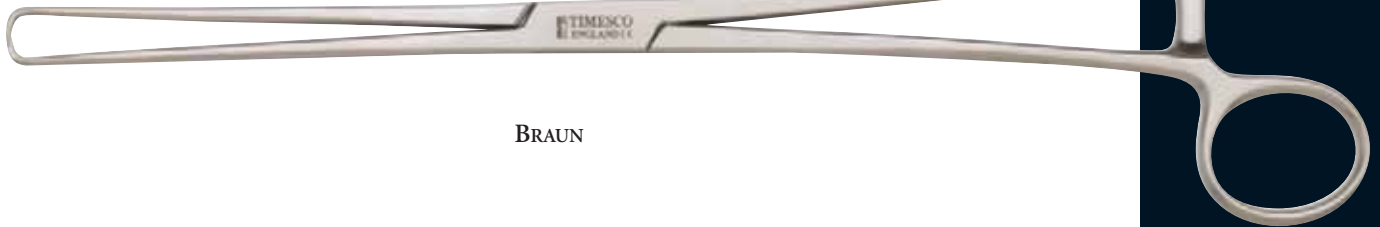

BRAUN

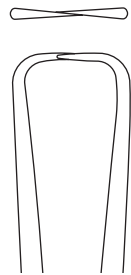

57.868.10 DUPLAY VULSELLUM FORCEP 11" (28CM) 1 X 1TH BOX JOINT

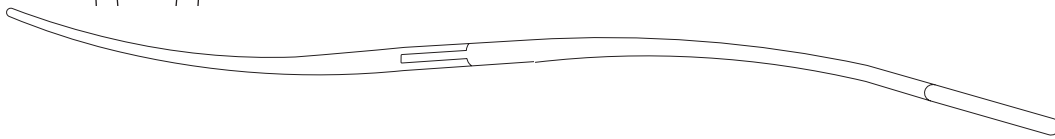

DUPLAY



57.880.10 LEWER VULSELLUM FORCEP 9.5" (24CM) 2 X 2TH BOX JOINT

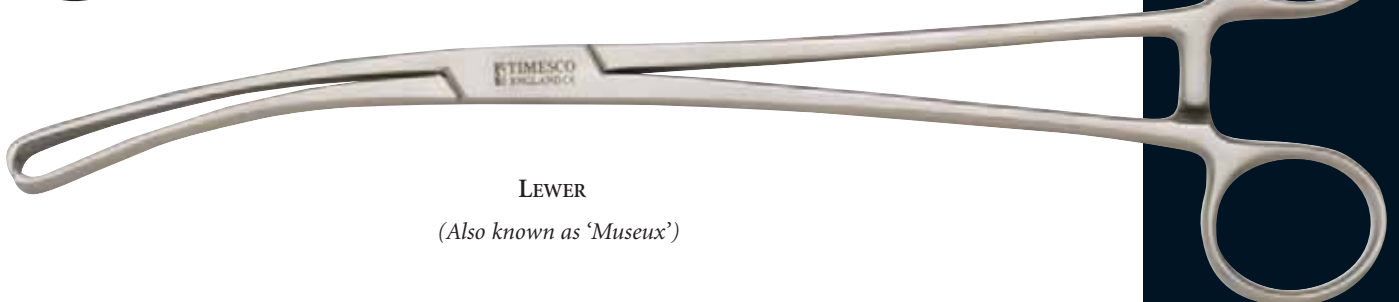

LEWER
(Also known as 'Museux')

TENACULUM/VULSELLUM FORCEPS

These forceps are referred to either as Vulsellum or Tenaculum. They perform the same function, to hold and manipulate the cervix with their sharp jaws.

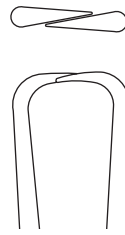

57.890.10 LUER VULSELLUM FORCEP 9.5" (24CM) 1 X 1TH BOX JOINT



LUER

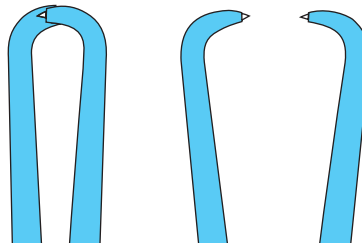

57.891.10S LUER VULSELLUM FORCEP 9.5" (24CM) 1 X 1TH BOX JOINT *BIC*



LUER

57.891.40 TIMESCO LUER VULSELLUM + SOUND 12" (30.5CM) BOX JOINT



TIMESCO LUER

TENACULUM/VULSELLUM FORCEPS

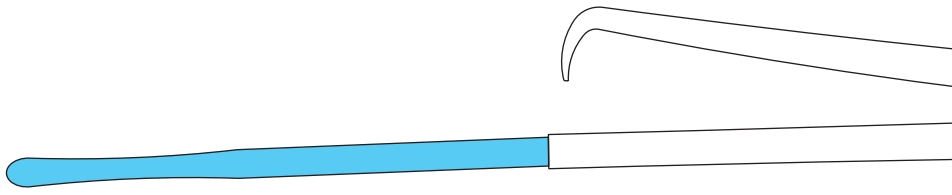

57.891.60 TIMESCO LUER VULSELLUM + SOUND 12" (30.5CM) *BIC*



TIMESCO LUER

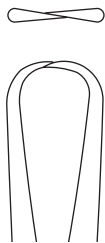

57.970.10 ROTUNDA VULSELLUM FORCEP 10.5" (27CM) 1 X 1TH



ROTUNDA

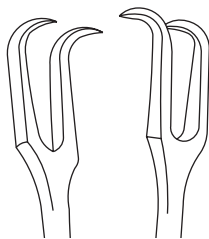

57.985.10 SCHROEDER VULSELLUM FORCEP 10.5" (27CM) 2 X 2



SCHROEDER

TENACULUM/VULSELLUM FORCEPS



57.995.10 TEAL VULSELLUM STRAIGHT 10.5" (27CM) 3 x 4TH BOX JOINT

57.995.30 TEAL VULSELLUM CURVED 7" (18CM) 3 x 4TH BOX JOINT

57.995.40 TEAL VULSELLUM CURVED 9.5" (24CM) 3 x 4TH BOX JOINT



TEAL

HOOKS



57.994.40S TENACULUM EMMETT 9" (23CM) *BIC*



EMETT



57.998.40S TENACULUM 3 PRONG 10.25" (26CM) *BIC*



3 PRONG

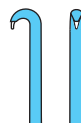

57.999.50 TIMESCO WHITTAKER 7.25" (18.5CM) *BIC*



WHITTAKER

The Timesco Whittaker hook also has a monopolar (Diathermy) terminal connection at the base of the handle.

ENDOCERVICAL CURETTES

Timesco's unique set of endocervical curettes are designed with special miniature heads to obtain endocervical biopsies from the OS. Their long length also allows endometrial tissue samples if required.

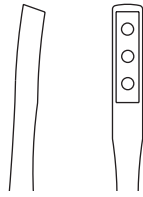

58.175.20 KEVORKIAN WITH BASKET SQUARE 12" (30.5CM)



KEVORKIAN

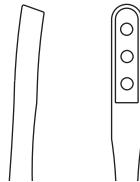

58.175.40 KEVORKIAN WITH BASKET ROUND 12" (30.5CM)



KEVORKIAN

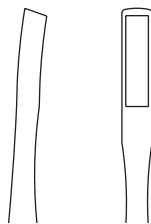

58.175.60 KEVORKIAN WITHOUT BASKET SQUARE 12" (30.5CM)



KEVORKIAN

UTERINE CURETTES

For curettage of the uterine walls Timesco produces an extensive range of curettes, some blunt edges, which are less traumatic, some sharp.



58.190.05
No. 00, 5MM



58.190.10
No. 0, 6MM



58.190.15
No. 1, 7MM



58.190.20
No. 2, 8MM

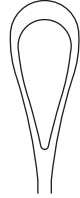

58.190.25
No. 3, 9MM

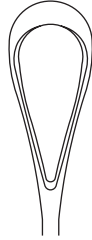

58.190.30
No. 4, 11MM



58.190.35
No. 5, 12MM

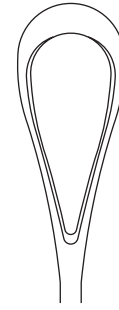

58.190.40
No. 6, 14MM

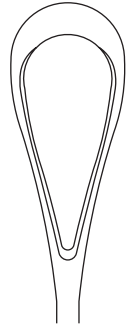

58.190.45
No. 7, 15MM

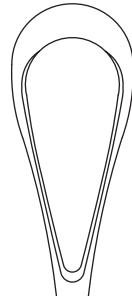

58.190.50
No. 8, 16MM

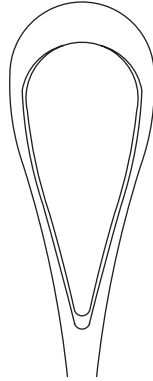

58.190.55
No. 9, 19MM

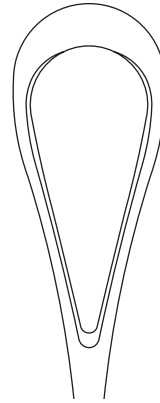

58.190.60
No. 10, 20MM

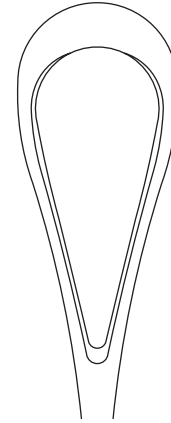

58.190.65
No. 11, 21MM

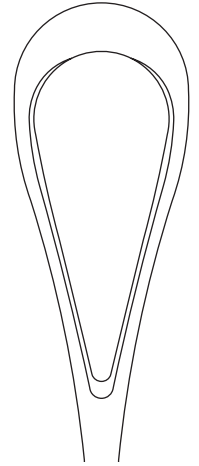

58.190.70
No. 12, 23MM

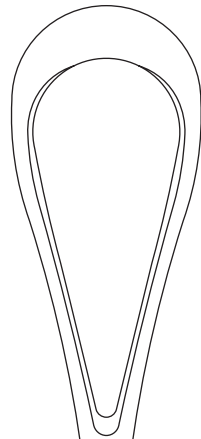

58.190.75
No. 13, 25MM

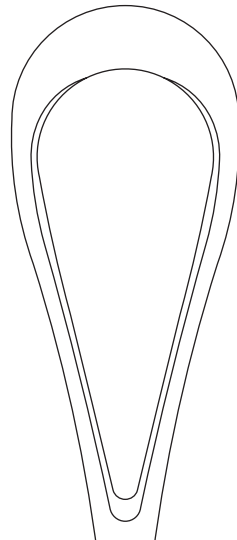

58.190.80
No. 14, 30MM

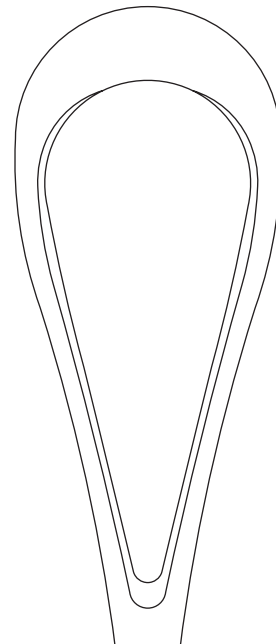

58.190.85
No. 15, 35MM

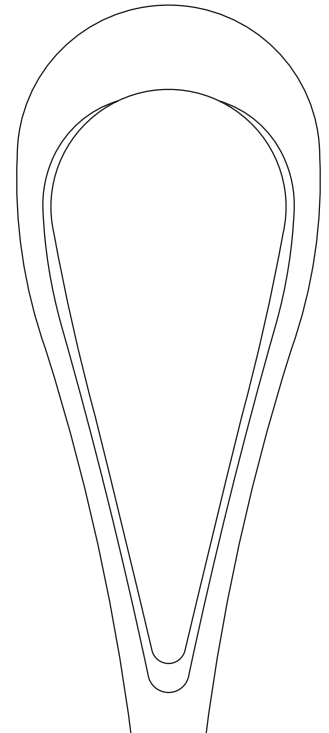

58.190.90
No. 16, 40MM

- 58.190.05 RECAMIER RIGID 00 5MM SHARP 12.5" (32CM)
- 58.190.10 RECAMIER RIGID 0 6MM SHARP 12.5" (32CM)
- 58.190.15 RECAMIER RIGID 1 7MM SHARP 12.5" (32CM)
- 58.190.20 RECAMIER RIGID 2 8MM SHARP 12.5" (32CM)
- 58.190.25 RECAMIER RIGID 3 9MM SHARP 12.5" (32CM)
- 58.190.30 RECAMIER RIGID 4 11MM SHARP 12.5" (32CM)
- 58.190.35 RECAMIER RIGID 5 12MM SHARP 12.5" (32CM)
- 58.190.40 RECAMIER RIGID 6 14MM SHARP 12.5" (32CM)
- 58.190.45 RECAMIER RIGID 7 15MM SHARP 12.5" (32CM)
- 58.190.50 RECAMIER RIGID 8 16MM SHARP 12.5" (32CM)
- 58.190.55 RECAMIER RIGID 9 19MM SHARP 12.5" (32CM)
- 58.190.60 RECAMIER RIGID 10 20MM SHARP 12.5" (32CM)
- 58.190.65 RECAMIER RIGID 11 21MM SHARP 12.5" (32CM)
- 58.190.70 RECAMIER RIGID 12 23MM SHARP 12.5" (32CM)
- 58.190.75 RECAMIER RIGID 13 25MM SHARP 12.5" (32CM)
- 58.190.80 RECAMIER RIGID 14 30MM SHARP 12.5" (32CM)
- 58.190.85 RECAMIER RIGID 15 35MM SHARP 12.5" (32CM)
- 58.190.90 RECAMIER RIGID 16 40MM SHARP 12.5" (32CM)

As well as single and double ended curettes, some, eg. Recamier, have malleable shafts, which can be bent to shape.

Curettes are also referred to as 'spoons'.



RECAMIER

- 58.195.05 RECAMIER MALLEABLE 00 5MM SHARP 12.5" (32CM)
- 58.195.10 RECAMIER MALLEABLE 0 6MM SHARP 12.5" (32CM)
- 58.195.15 RECAMIER MALLEABLE 1 7MM SHARP 12.5" (32CM)
- 58.195.20 RECAMIER MALLEABLE 2 8MM SHARP 12.5" (32CM)
- 58.195.25 RECAMIER MALLEABLE 3 9MM SHARP 12.5" (32CM)
- 58.195.30 RECAMIER MALLEABLE 4 11MM SHARP 12.5" (32CM)
- 58.195.35 RECAMIER MALLEABLE 5 12MM SHARP 12.5" (32CM)
- 58.195.40 RECAMIER MALLEABLE 6 14MM SHARP 12.5" (32CM)
- 58.195.45 RECAMIER MALLEABLE 7 15MM SHARP 12.5" (32CM)
- 58.195.50 RECAMIER MALLEABLE 8 16MM SHARP 12.5" (32CM)
- 58.195.55 RECAMIER MALLEABLE 9 19MM SHARP 12.5" (32CM)
- 58.195.60 RECAMIER MALLEABLE 10 20MM SHARP 12.5" (32CM)
- 58.195.65 RECAMIER MALLEABLE 11 21MM SHARP 12.5" (32CM)
- 58.195.70 RECAMIER MALLEABLE 12 23MM SHARP 12.5" (32CM)
- 58.195.75 RECAMIER MALLEABLE 13 25MM SHARP 12.5" (32CM)
- 58.195.80 RECAMIER MALLEABLE 14 30MM SHARP 12.5" (32CM)
- 58.195.85 RECAMIER MALLEABLE 15 35MM SHARP 12.5" (32CM)
- 58.195.90 RECAMIER MALLEABLE 16 40MM SHARP 12.5" (32CM)

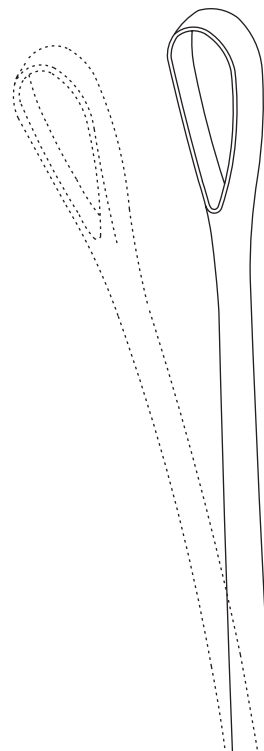

UTERINE CURETTES

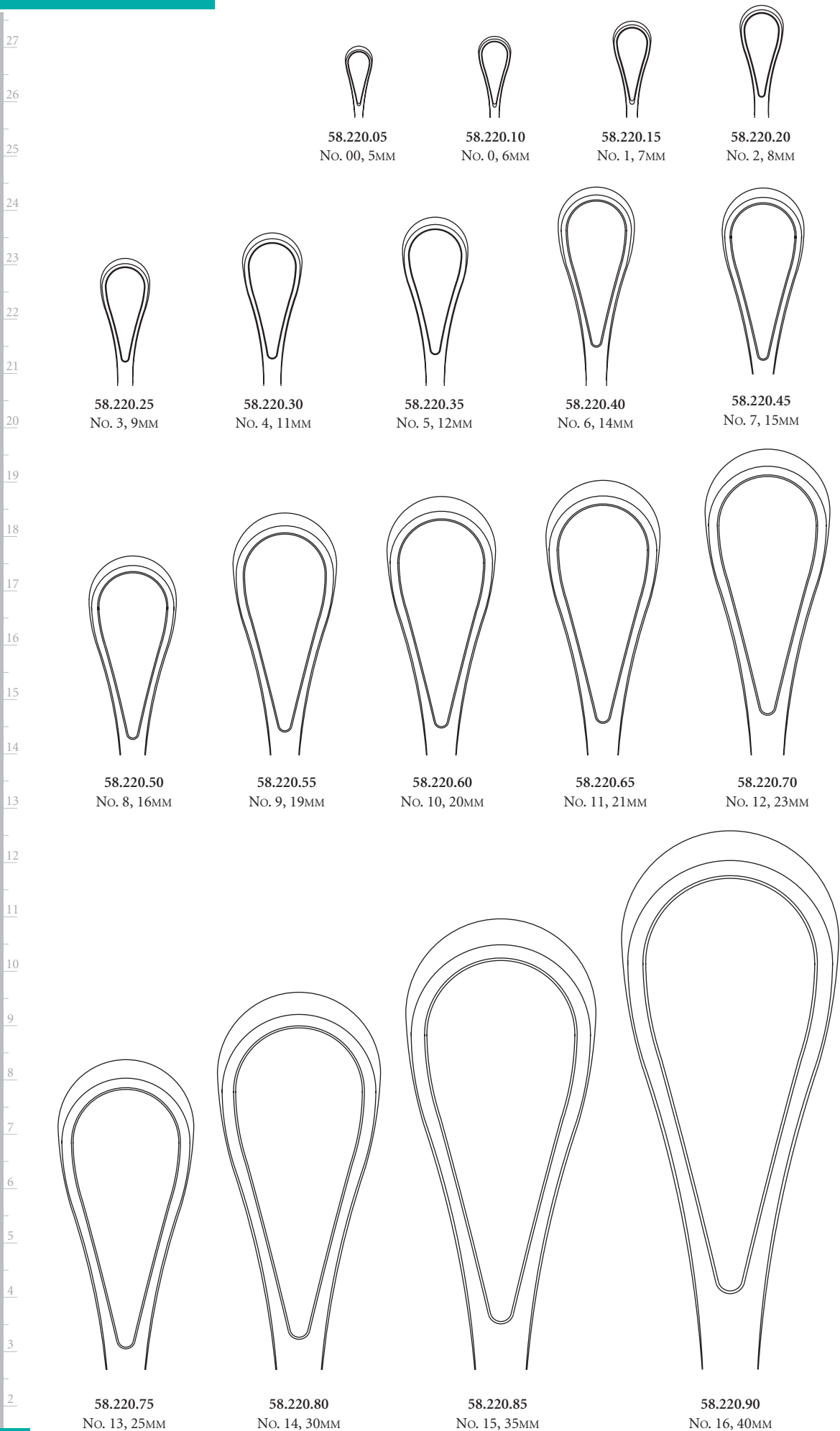



- 58.220.05 RECAMIER RIGID 00 5MM BLUNT 12.5" (32CM)
- 58.220.10 RECAMIER RIGID 0 6MM BLUNT 12.5" (32CM)
- 58.220.15 RECAMIER RIGID 1 7MM BLUNT 12.5" (32CM)
- 58.220.20 RECAMIER RIGID 2 8MM BLUNT 12.5" (32CM)
- 58.220.25 RECAMIER RIGID 3 9MM BLUNT 12.5" (32CM)
- 58.220.30 RECAMIER RIGID 4 11MM BLUNT 12.5" (32CM)
- 58.220.35 RECAMIER RIGID 5 12MM BLUNT 12.5" (32CM)
- 58.220.40 RECAMIER RIGID 6 14MM BLUNT 12.5" (32CM)
- 58.220.45 RECAMIER RIGID 7 15MM BLUNT 12.5" (32CM)
- 58.220.50 RECAMIER RIGID 8 16MM BLUNT 12.5" (32CM)
- 58.220.55 RECAMIER RIGID 9 19MM BLUNT 12.5" (32CM)
- 58.220.60 RECAMIER RIGID 10 20MM BLUNT 12.5" (32CM)
- 58.220.65 RECAMIER RIGID 11 21MM BLUNT 12.5" (32CM)
- 58.220.70 RECAMIER RIGID 12 23MM BLUNT 12.5" (32CM)
- 58.220.75 RECAMIER RIGID 13 25MM BLUNT 12.5" (32CM)
- 58.220.80 RECAMIER RIGID 14 30MM BLUNT 12.5" (32CM)
- 58.220.85 RECAMIER RIGID 15 35MM BLUNT 12.5" (32CM)
- 58.220.90 RECAMIER RIGID 16 40MM BLUNT 12.5" (32CM)



RECAMIER

- 58.225.05 RECAMIER MALLEABLE 00 5MM BLUNT 12.5" (32CM)
- 58.225.10 RECAMIER MALLEABLE 0 6MM BLUNT 12.5" (32CM)
- 58.225.15 RECAMIER MALLEABLE 1 7MM BLUNT 12.5" (32CM)
- 58.225.20 RECAMIER MALLEABLE 2 8MM BLUNT 12.5" (32CM)
- 58.225.25 RECAMIER MALLEABLE 3 9MM BLUNT 12.5" (32CM)
- 58.225.30 RECAMIER MALLEABLE 4 11MM BLUNT 12.5" (32CM)
- 58.225.35 RECAMIER MALLEABLE 5 12MM BLUNT 12.5" (32CM)
- 58.225.40 RECAMIER MALLEABLE 6 14MM BLUNT 12.5" (32CM)
- 58.225.45 RECAMIER MALLEABLE 7 15MM BLUNT 12.5" (32CM)
- 58.225.50 RECAMIER MALLEABLE 8 16MM BLUNT 12.5" (32CM)
- 58.225.55 RECAMIER MALLEABLE 9 19MM BLUNT 12.5" (32CM)
- 58.225.60 RECAMIER MALLEABLE 10 20MM BLUNT 12.5" (32CM)
- 58.225.65 RECAMIER MALLEABLE 11 21MM BLUNT 12.5" (32CM)
- 58.225.70 RECAMIER MALLEABLE 12 23MM BLUNT 12.5" (32CM)
- 58.225.75 RECAMIER MALLEABLE 13 25MM BLUNT 12.5" (32CM)
- 58.225.80 RECAMIER MALLEABLE 14 30MM BLUNT 12.5" (32CM)
- 58.225.85 RECAMIER MALLEABLE 15 35MM BLUNT 12.5" (32CM)
- 58.225.90 RECAMIER MALLEABLE 16 40MM BLUNT 12.5" (32CM)

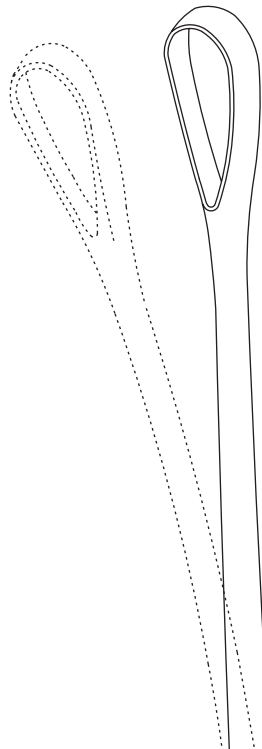

UTERINE CURETTES



58.310.10



58.310.20

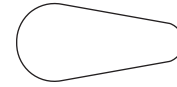

58.310.30

58.310.10 SIMS SINGLE ENDED SMALL $\frac{1}{4}$ " (6MM) SHARP 10" (25.5CM)

58.310.20 SIMS SINGLE ENDED MEDIUM $\frac{3}{8}$ " (9MM) SHARP 10" (25.5CM)

58.310.30 SIMS SINGLE ENDED LARGE $\frac{1}{2}$ " (12MM) SHARP 10" (25.5CM)

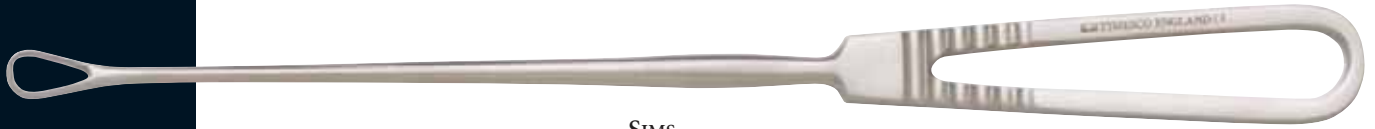

SIMS
SINGLE ENDED SHARP



58.310.50

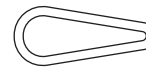

58.310.60

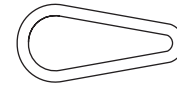

58.310.70

58.310.50 SIMS SINGLE ENDED SMALL $\frac{1}{4}$ " (6MM) BLUNT 10" (25.5CM)

58.310.60 SIMS SINGLE ENDED MEDIUM $\frac{3}{8}$ " (9MM) BLUNT 10" (25.5CM)

58.310.70 SIMS SINGLE ENDED LARGE $\frac{1}{2}$ " (12MM) BLUNT 10" (25.5CM)



SIMS
SINGLE ENDED BLUNT



58.315.10



58.315.20

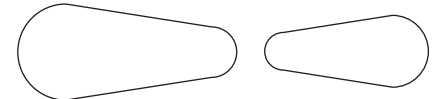

58.315.30

58.315.10 SIMS DOUBLE ENDED SMALL ($\frac{1}{4}$ " x $\frac{3}{16}$ ") (6MM x 5MM) SHARP SHARP 10" (25.5CM)

58.315.20 SIMS DOUBLE ENDED MEDIUM ($\frac{3}{8}$ " x $\frac{1}{4}$ ") (9MM x 6MM) SHARP SHARP 10" (25.5CM)

58.315.30 SIMS DOUBLE ENDED LARGE ($\frac{1}{2}$ " x $\frac{3}{8}$ ") (12MM x 9MM) SHARP SHARP 10" (25.5CM)



SIMS
DOUBLE ENDED SHARP SHARP



58.315.50



58.315.60

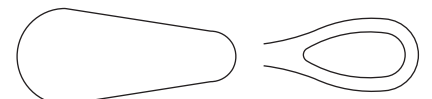

58.315.70

58.315.50 SIMS DOUBLE ENDED SMALL ($\frac{1}{4}$ " x $\frac{3}{16}$ ") (6MM x 5MM) SHARP BLUNT 10" (25.5MM)

58.315.60 SIMS DOUBLE ENDED MEDIUM ($\frac{3}{8}$ " x $\frac{1}{4}$ ") (9MM x 6MM) SHARP BLUNT 10" (25.5MM)

58.315.70 SIMS DOUBLE ENDED LARGE ($\frac{1}{2}$ " x $\frac{3}{8}$ ") (12MM x 9MM) SHARP BLUNT 10" (25.5MM)



SIMS
DOUBLE ENDED SHARP BLUNT

FLUSHING CURETTES

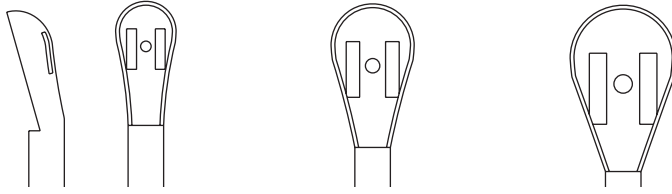

58.330.10

58.330.20

58.330.30

58.330.10 RHEINSTADTER SMALL 11.5" (29CM) 5/16" (8MM) SHARP

58.330.20 RHEINSTADTER MEDIUM 11.5" (29CM) 7/16" (11MM) SHARP

58.330.30 RHEINSTADTER LARGE 11.5" (29CM) 9/16" (14MM) SHARP

Curettes (flushing) such as RHEINSTADTER are cannulated and are used with suction to evacuate the uterine cavity. All cannulated curettes are supplied with cleaning stilletes.



RHEINSTADTER

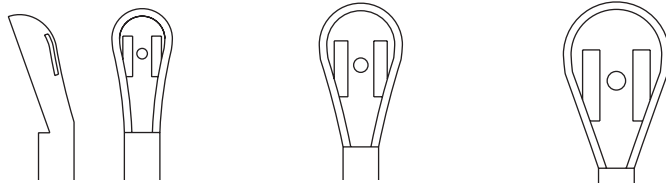

58.330.50

58.330.60

58.330.70

58.330.50 RHEINSTADTER SMALL 11.5" (29CM) 5/16" (8MM) BLUNT

58.330.60 RHEINSTADTER MEDIUM 11.5" (29CM) 7/16" (11MM) BLUNT

58.330.70 RHEINSTADTER LARGE 11.5" (29CM) 9/16" (14MM) BLUNT



RHEINSTADTER

BIOPSY CURETTES

○ 12FG 4mm

58.360.20 LEECH WILKINSON SUCTION 12FG 10" (25.5CM)



LEECH WILKINSON

BIOPSY CURETTES

Timesco's range of Endometrial curettes feature all the popular European and North American patterns, for sampling the Endometrial tissue.

All the curettes feature rounded ends to avoid perforation of the uterus and sharp cutting retrograde teeth that take clean biopsies with ease. Cleaning stillettes are supplied with all cannulated curettes.

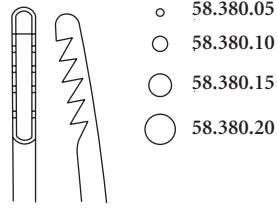

- 58.380.05 NOVAK SUCTION 1MM 10" (25.5CM)
- 58.380.10 NOVAK SUCTION 2MM 10" (25.5CM)
- 58.380.15 NOVAK SUCTION 3MM 10" (25.5CM)
- 58.380.20 NOVAK SUCTION 4MM 10" (25.5CM)



NOVAK

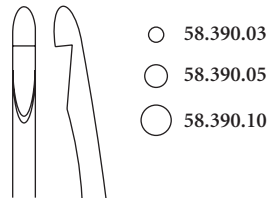

- 58.390.03 RANDALL SUCTION 2MM 10" (25.5CM)
- 58.390.05 RANDALL SUCTION 3MM 10" (25.5CM)
- 58.390.10 RANDALL SUCTION 4MM 10" (25.5CM)



RANDALL

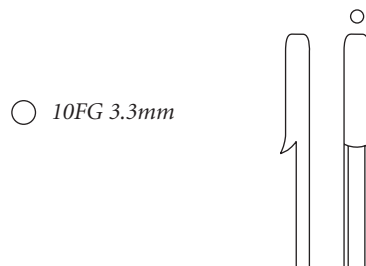

- 58.395.10 SHARMAN ENDOMETRIAL 10FG 9" (23CM) C/P

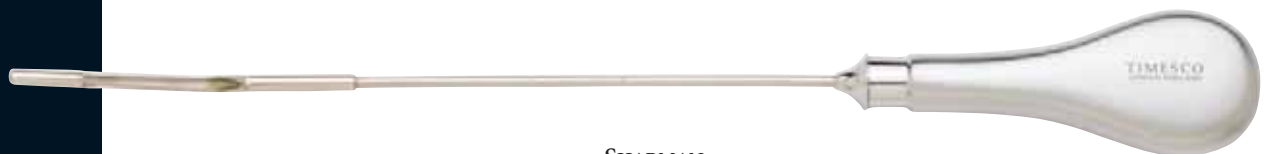

SHARMAN

Timesco offers two standard depressors, Sims and Braun. These are used to apply pressure on the anterior cul-de-sac, exposing the OS. The Sims feature serrated non-sharp faces, which hold the walls without slipping.

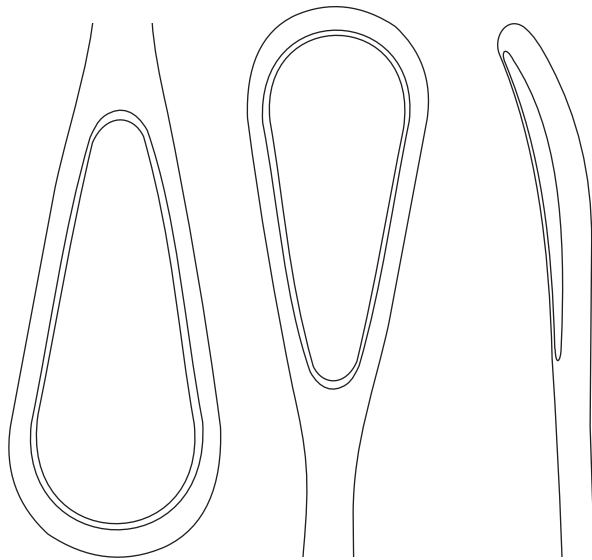

58.410.10 BRAUN UTERINE DOUBLE ENDED 11" (28CM)



BRAUN

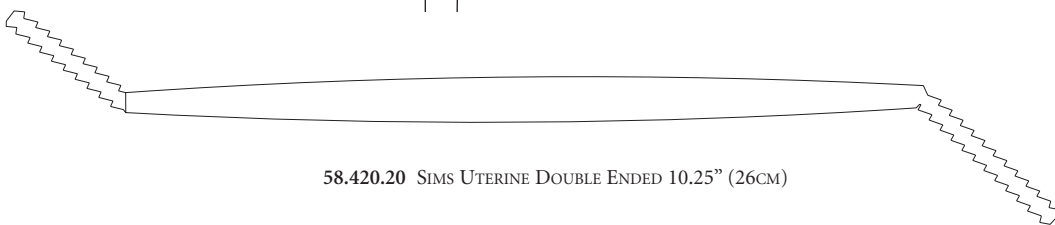
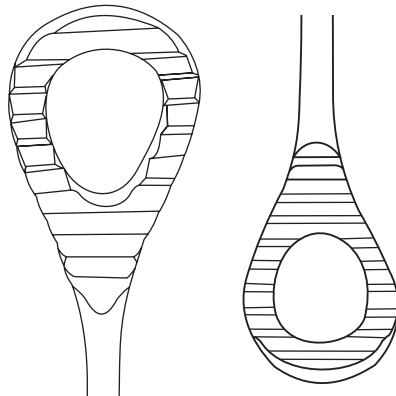

58.420.20 SIMS UTERINE DOUBLE ENDED 10.25" (26CM)



SIMS

UTERUS HOLDING FORCEPS

These forceps are designed to hold the complete uterus in their jaws without rupturing the sac, especially during operations for prolapse.

27
26
25
24
23
21
20
19
18
17
16
15
14
13
12
11
10
9
8
7
6
5
4
3
2

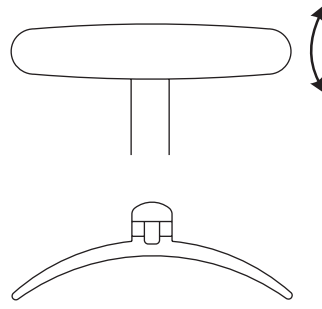

58.430.10 COLLIN UTERINE 10" (25.5CM) SCREW JOINT
(Also known as 'Shirodkar')

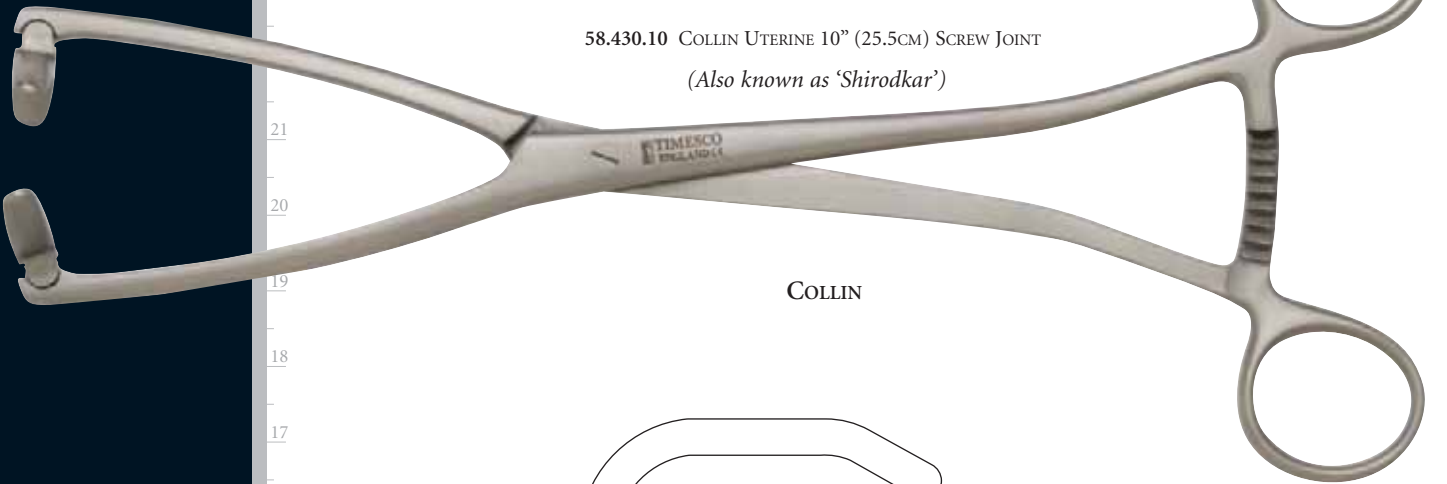

COLLIN

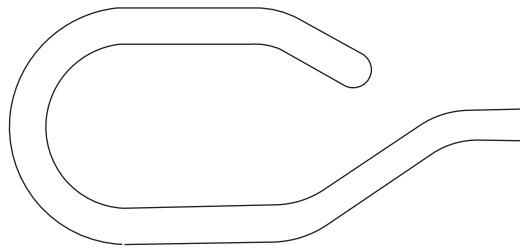

58.440.20 DARTIGUE 10.5" (27CM) SCREW JOINT



DARTIGUE

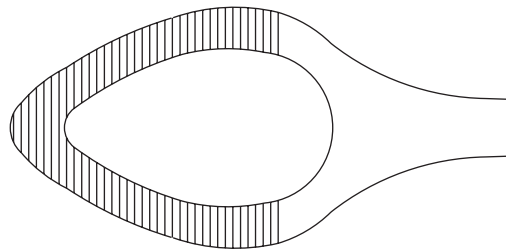

58.460.20 SOMER FORCEP 10" (25.5CM) SCREW JOINT

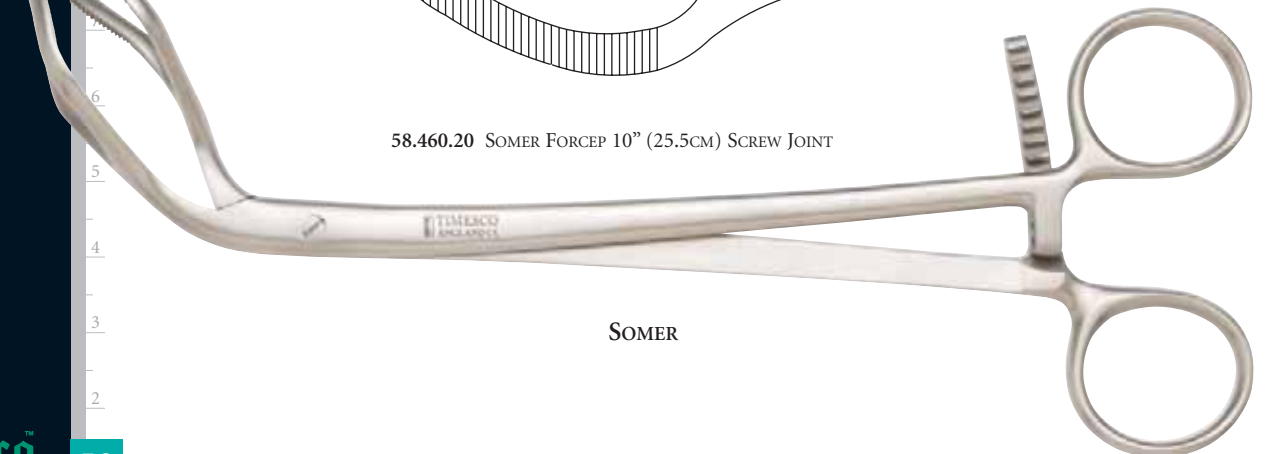

SOMER

HYSTERECTOMY CLAMPS

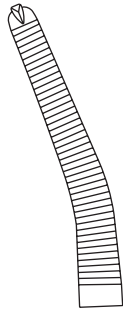

58.480.20 BONNEY ANGLED 8" (20CM) 1 X 2TH SCREW JOINT

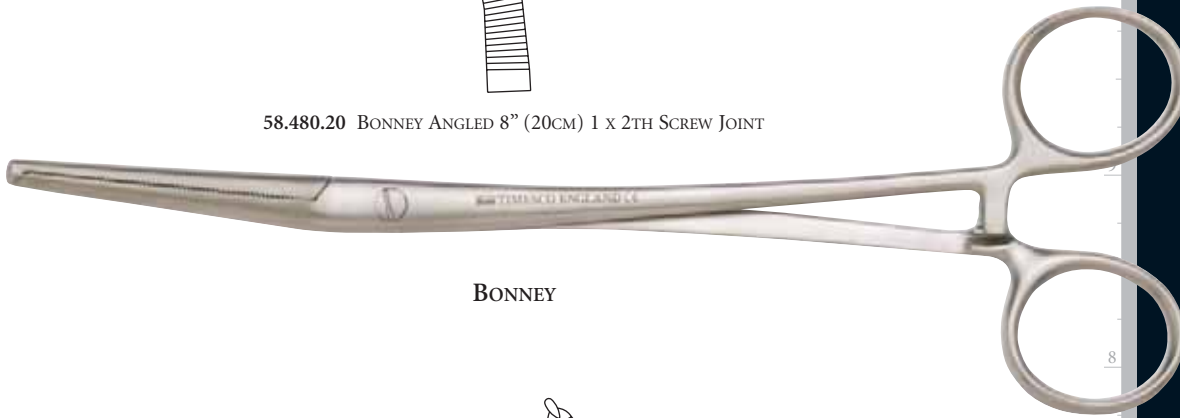

BONNEY

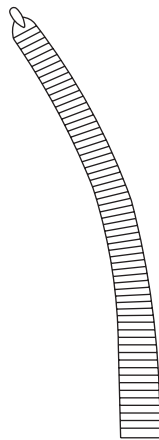

58.485.20 BONNEY-BERKLEY CURVED 8" (20CM) 1 X 2TH SCREW JOINT

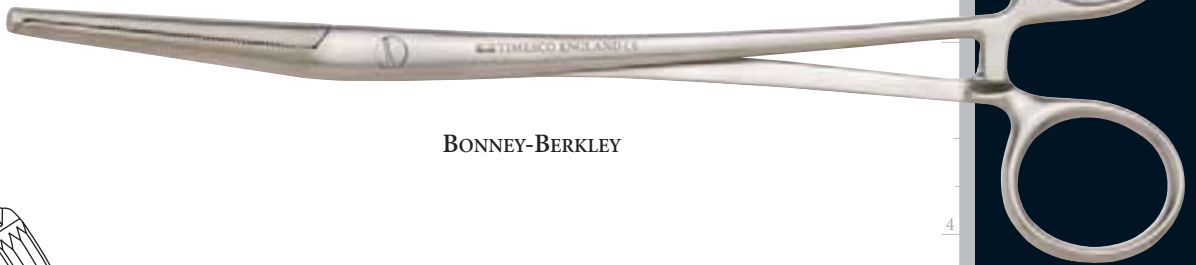

BONNEY-BERKLEY

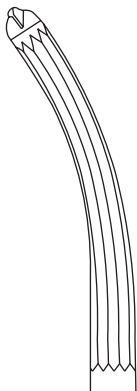
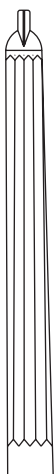

58.515.20 GWILLIAM STRAIGHT 8" (20CM) BOX JOINT

58.515.40 GWILLIAM CURVED 8" (20CM) BOX JOINT



GWILLIAM

Hysterectomy clamps are heavier, powerful versions of haemostatic forceps and are referred to as 'clamps'. These feature thick strong jaws and shanks. Due to the nature of their use, their jaws are serrated mainly longitudinally to hold and occlude, without slipping.

Many varieties of the Hysterectomy forceps are available. Timesco also manufacture the Timesco Parametrium forceps, which features special non-slip grooves and powerful jaws, which are precision made to prevent slipping and trauma.

HYSTERECTOMY CLAMPS

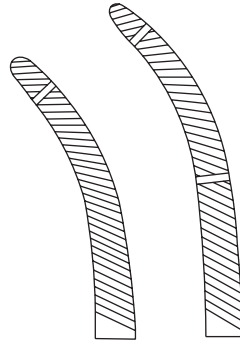

58.520.20 HEANEY CURVED 8" (20CM) 1-TOOTH BOX JOINT

58.520.40 HEANEY CURVED 8" (20CM) 2-TEETH BOX JOINT

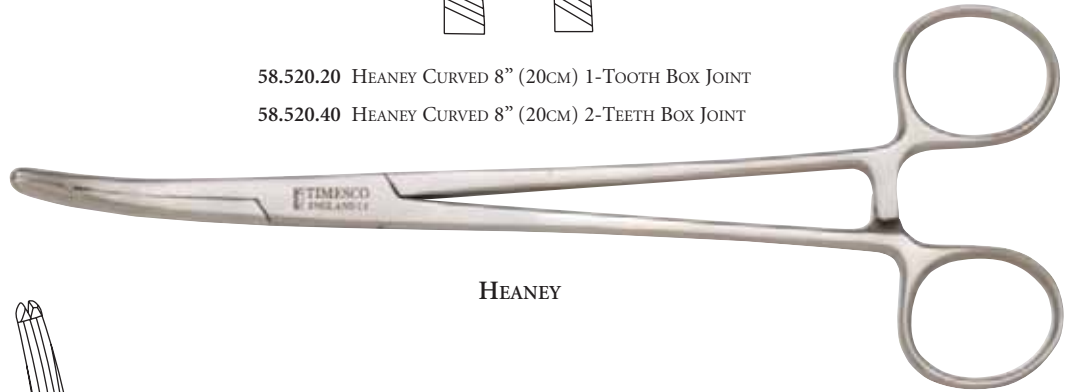

HEANEY

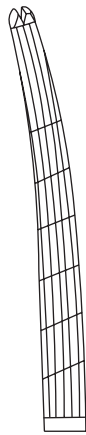

58.540.20 HUNTER CURVED 9" (23CM) BOX JOINT

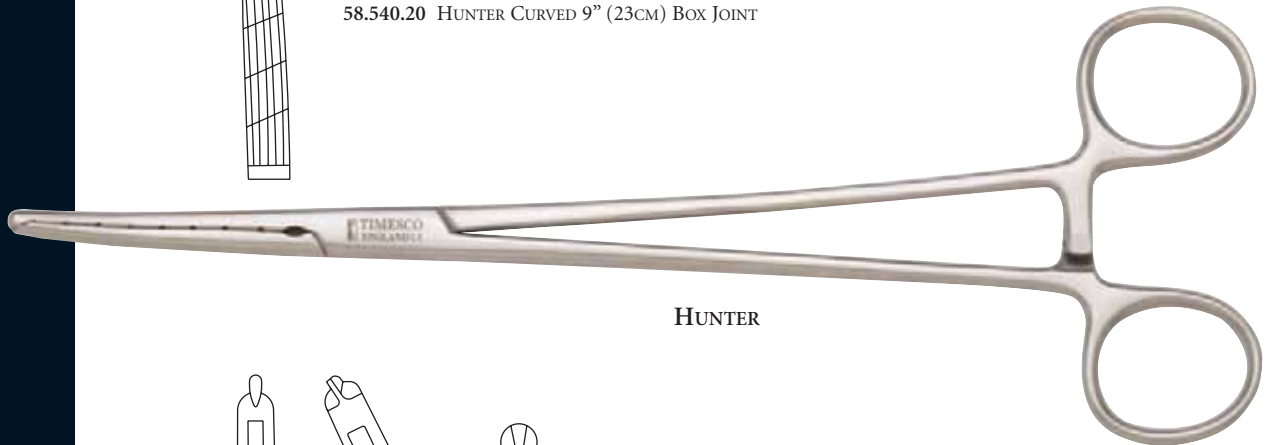

HUNTER

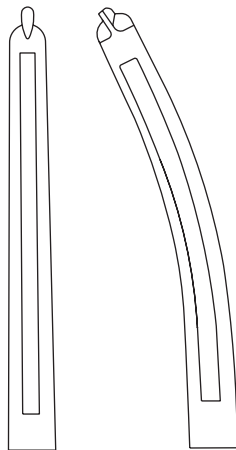

58.550.20 MAINGOT STRAIGHT 8" (20CM) BOX JOINT

58.550.40 MAINGOT CURVED 8" (20CM) BOX JOINT



MAINGOT

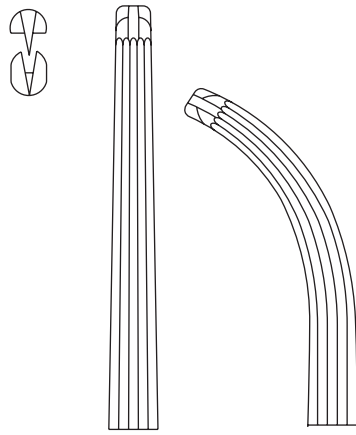

58.555.20 McCULLAGH STRAIGHT 8.75" (22CM) BOX JOINT

58.555.40 McCULLAGH CURVED 9" (23CM) BOX JOINT



McCULLAGH

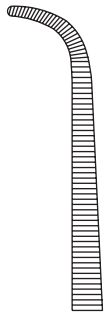

58.565.10 NAVRATILL VAGINAL CURVED 9" (23CM) BOX JOINT



NAVRATILL

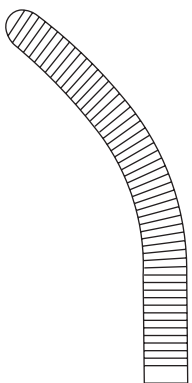

58.760.10 WERTHEIM PARAMETRIUM CURVED 10" (25.5CM) BOX JOINT



WERTHEIM

HYSTERECTOMY CLAMPS

These feature 'Debakey' type non-traumatic jaws which hold without crushing.

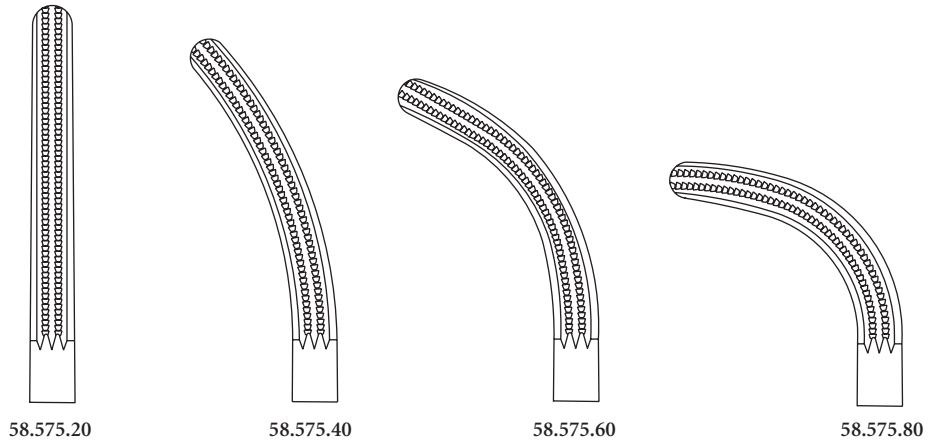

58.575.20

58.575.40

58.575.60

58.575.80

58.575.20 TIMESCO PARAMETRIUM STRAIGHT no:1 8.75" (22CM)

58.575.40 TIMESCO PARAMETRIUM SLIGHTLY CURVED no:2 8.75" (22CM)

58.575.60 TIMESCO PARAMETRIUM MEDIUM CURVED no:3 8.75" (22CM)

58.575.80 TIMESCO PARAMETRIUM FULL CURVED no:4 8.75" (22CM)

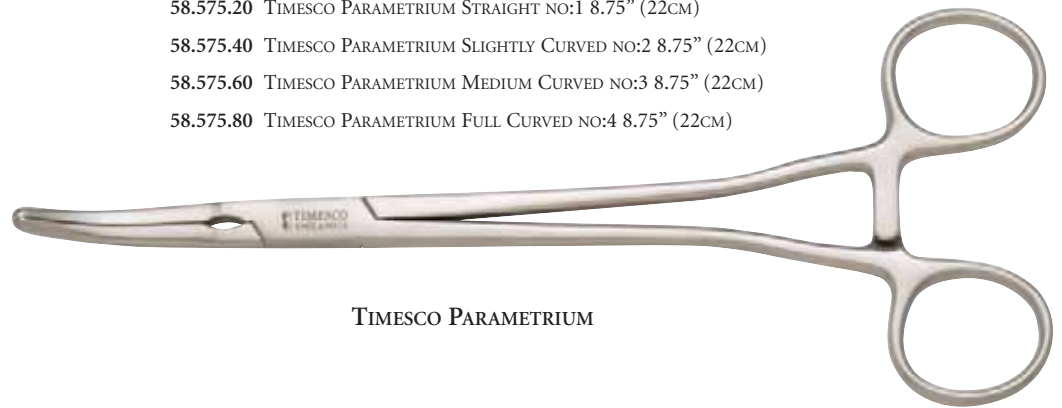

TIMESCO PARAMETRIUM

INSUFFLATION CANNULAS

From the 'screw' tip type, Leech Wilkinson, to the stopcock type, Curries, Timesco offers a complete range of cannulas for insufflation of the Uterus.

○ 12FG 4mm

58.655.20 CURRIE RUBBER CONE 14" (35.5CM) 12FG WITH STOPCOCK



CURRIE

○ 10FG 3.33mm

58.660.20 HAYES-PROVIS 10" (25.5CM) 10FG



HAYES-PROVIS

INSUFFLATION CANNULAS

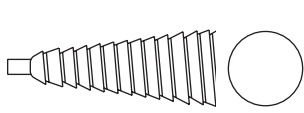

58.655.10 10mm

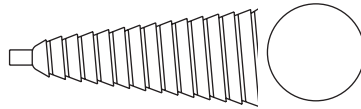

58.655.20 13mm

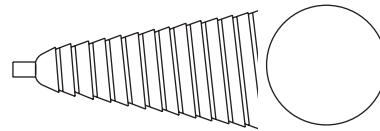

58.655.30 16mm

- 58.655.10 LEECH WILKINSON SMALL 10" (25.5CM) C/P
- 58.655.20 LEECH WILKINSON MEDIUM 10" (25.5CM) C/P
- 58.655.30 LEECH WILKINSON LARGE 10" (25.5CM) C/P

Some cannulas, eg. Spackman cannula have a travelling bar into which a Vulsellum forceps can be hooked to station the cannula in the cervix.



LEECH WILKINSON

○ 10FG 3.33mm

58.670.20 PROVIS RUBBER CONE 8" (20CM) 10FG



PROVIS

○ 10FG 3.33mm

58.675.40 PROVIS METAL CONE 7.75" (19.5CM) 10FG



PROVIS

Timesco cannulas are available with metal, or latex free autoclavable rubber 'acorns'. All cannulas are supplied with a cleaning stillette.

○ 12FG 4mm

58.680.10 SPACKMAN RUBBER CONE 14.75" (37.5CM) 12FG



SPACKMAN



○ 12FG 4mm

58.690.20 SPACKMAN METAL CONE 14.75" (37.5CM) 12FG

○ 18FG 6mm

58.690.30 SPACKMAN METAL CONE 14.75" (37.5CM) 18FG



SPACKMAN



This is a universal size and can be used on all Cannulas with 10FG and 12FG sizes.

58.685.10 SPACKMAN RUBBER ONLY 'ACORN'

MYOMA SCREWS

The Doyen Myoma screws are designed to remove fibroids (myomas). After an initial incision is made in the uterine wall to expose the fibroid, the myoma screw is screwed into it, and pulled to enucleate the growth.

27
26
25
24
23
22
21
20
19
18
17
16
15
14
13
12

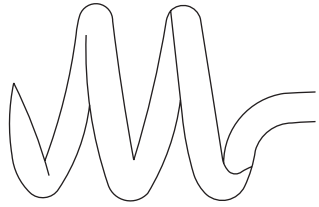

58.725.10 DOYEN FOR ABDOMEN 7" (18CM) (LARGE)



DOYEN MYOMA

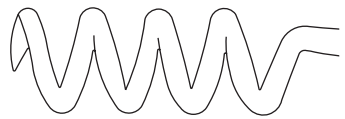

58.725.20 DOYEN FOR VAGINA 7" (18CM) (SMALL)

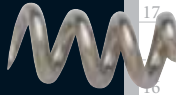

DOYEN MYOMA



MYOMECTOMY CLAMPS

Like its Hysterectomy clamp namesake, this clamp was principally designed for use in Myomectomy procedures. The clamp is applied from the front to the lower

segment of the uterus to include the round ligaments and to compress the uterine vessels.

10
9
8
7
6
5
4
3
2

58.730.10 BONNEY 10.5" (27CM) SCREW JOINT



BONNEY

POLYPUS FORCEPS



58.770.10 BONNEY 9.5" (24CM) BOX JOINT

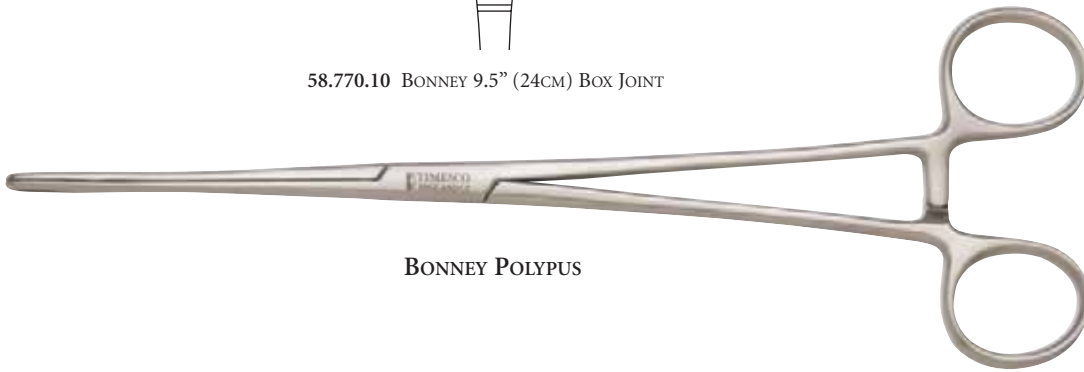

BONNEY POLYPUS

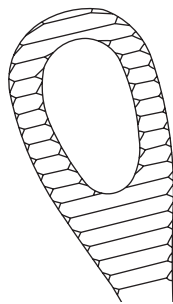

58.795.10 KELLY 12.5" (32CM) BOX JOINT

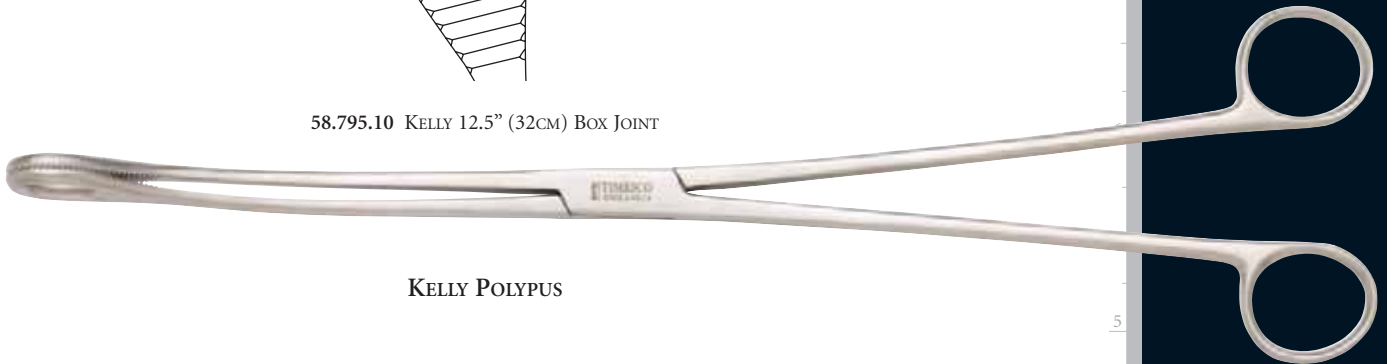

KELLY POLYPUS

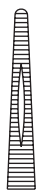

58.799.50S TIMESCO 10.5" (27CM) NARROW SCREW JOINT



TIMESCO POLYPUS

This forcep is also useful due to its narrow, elongated jaw in IUCD procedures.

The Bonney Polypus forceps are a very popular instrument, which are also referred to as a 'Ring Forcep'. Due to its narrow jaw, it can be passed through a narrowly dilated cervix to remove Polyps from the uterus or cervical canal.

Polypus forceps are so named for removing 'Polyps' from the uterus.

The larger jawed patterns (eg. Kelly) are also used as general purpose instruments in Gynaecological procedures.

UTERINE SOUNDS

Timesco uterine sounds are made especially from quality copper rod, which is then electroplated in silver. The copper rod is graduated and allows malleability so that the sounds can be shaped to the shape of the uterus.

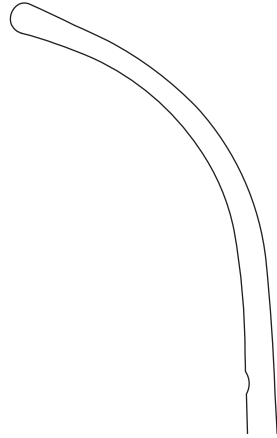

58.815.20 GALABIN 12" (30.5CM) TIP 4MM, S/P



GALABIN

The tips of the sounds are rounded to prevent perforation of the uterus walls.

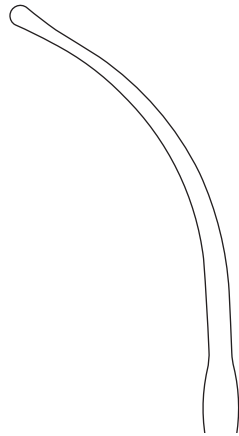

58.820.20 HORROCK 11" (28CM) TIP 3MM, S/P



HORROCK

The sounds are graduated in cm to measure the depth of insertion into the uterine cavity.

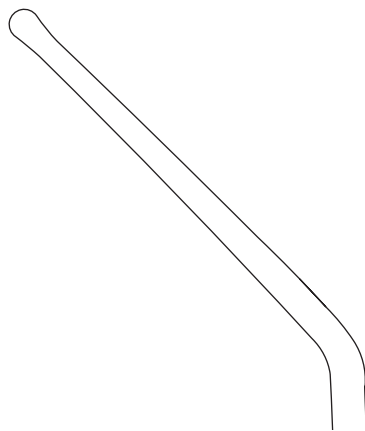

58.830.20 SIMPSON 12" (30.5CM) TIP 4MM, S/P



SIMPSON

UTERINE SOUNDS

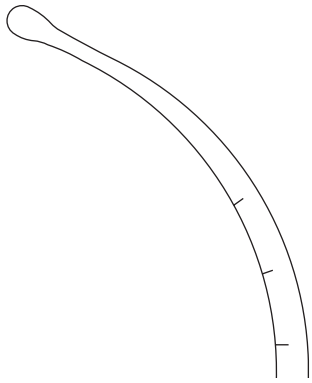

58.840.20 SIMS 12.5" (32CM) TIP 4MM, S/P



SIMS

IUCD UTERINE HOOKS



58.870.20 GRAFENBERG HOOK 5MM 12.5" (32CM)



GRAFENBERG

IUCD REMOVAL FORCEPS

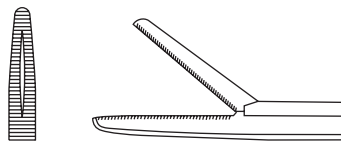
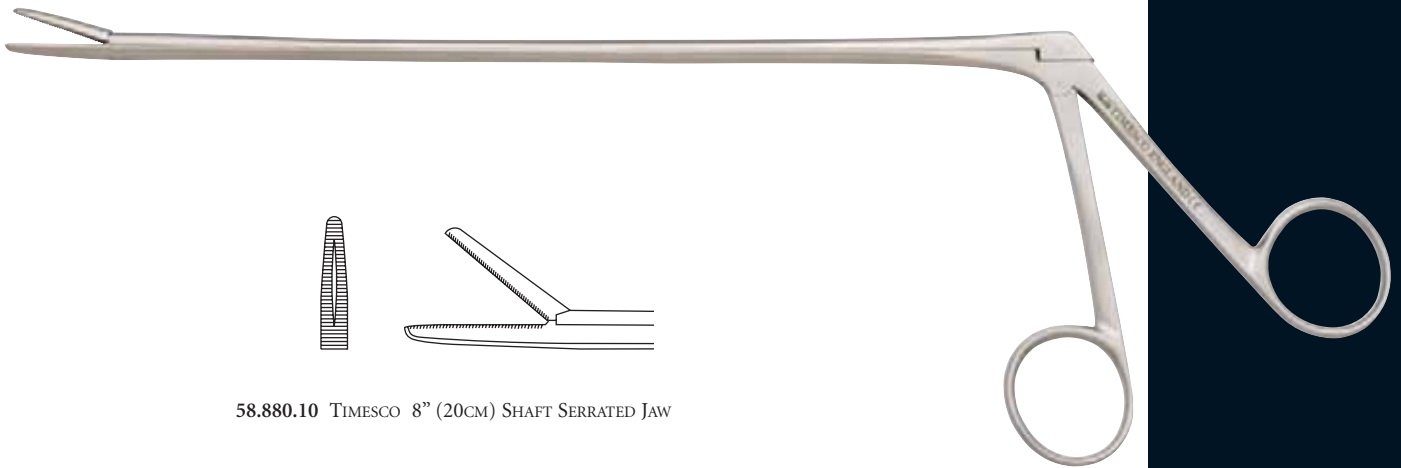

58.880.10 TIMESCO 8" (20CM) SHAFT SERRATED JAW

Timesco produce the classic crocodile action IUCD removing forceps, which is referred to as the WHO (World Health Organisation) type. Also much simpler inexpensive hook type thread/coil removers are available such as the Grafenburg hook.

CAESAREAN SECTION FORCEPS

The Green Armytage forceps are classic Haemostatic forceps, which are used, in lower segment of caesarean sections.

The jaws feature large serrated faces, which occlude the sinuses without trauma or crushing.

The original design was subsequently modified and is available in angled form also.

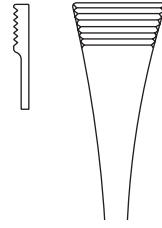

61.100.20 GREEN-ARMYTAGE STRAIGHT 8" (20CM) SCREW JOINT



GREEN-ARMYTAGE

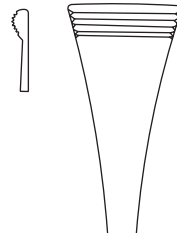

61.100.30 GREEN-ARMYTAGE ANGLED 7.75" (19.5CM) SCREW JOINT



GREEN-ARMYTAGE

INDUCTION CATHETERS

The Drew Smyth catheter ruptures the membranes of the amniotic sac. In particular it was designed to puncture the hind waters and to evacuate the amniotic fluid.

61.115.20 DREW SMYTHE 8EG 13.75" (35CM) S/P

○ 8EG 5mm



DREW SMYTHE

61.125.10 BRAUN CRANIOCLAST 16.5" (35CM)



BRAUN

61.150.10 WINTER CRANIOCLAST + CEPHALOTRIBE 16.5" (35CM)

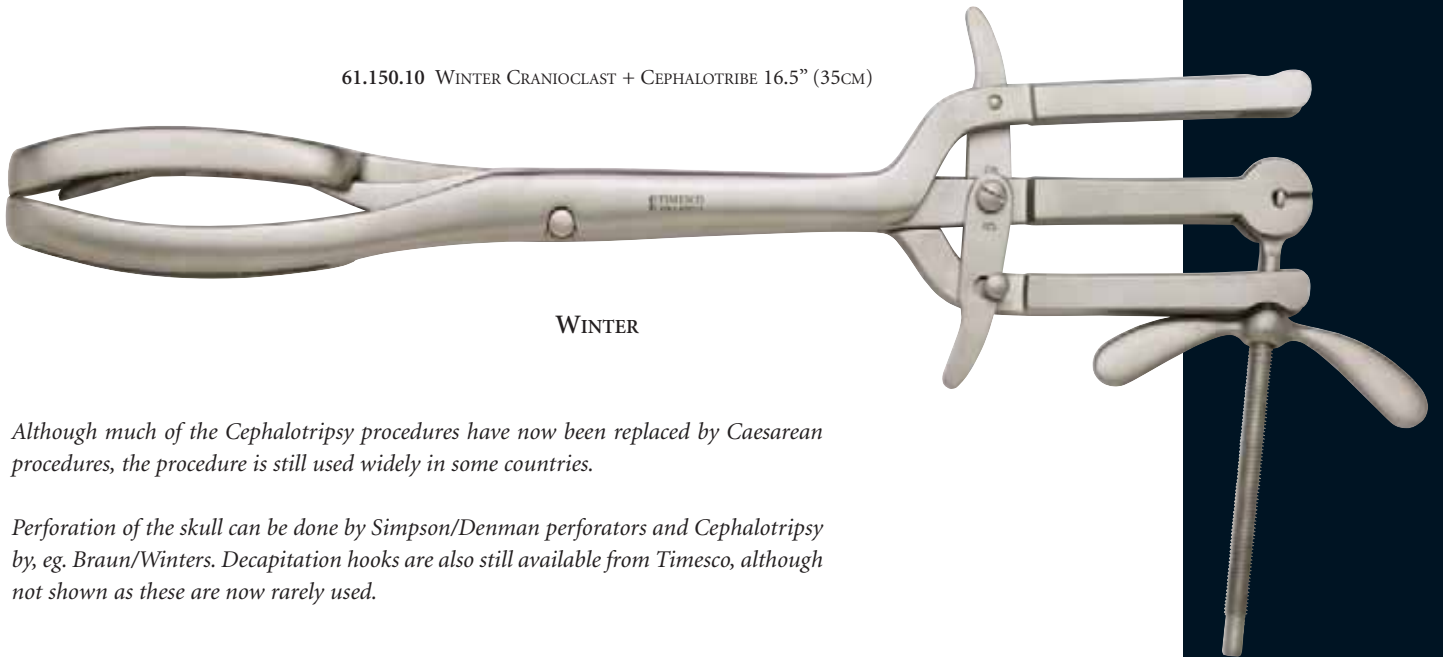

WINTER

Although much of the Cephalotripsy procedures have now been replaced by Caesarean procedures, the procedure is still used widely in some countries.

Perforation of the skull can be done by Simpson/Denman perforators and Cephalotripsy by, eg. Braun/Winters. Decapitation hooks are also still available from Timesco, although not shown as these are now rarely used.

UTERUS EVACUATION/ASPIRATION CURETTES

61.160.10



61.160.20



61.160.30



61.160.40



61.160.50

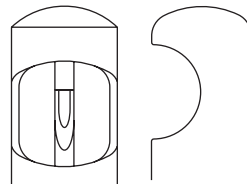

61.160.10 BIERER ASPIRATION CURETTE 11" (28CM) 8MM

61.160.20 BIERER ASPIRATION CURETTE 11" (28CM) 10MM

61.160.30 BIERER ASPIRATION CURETTE 11" (28CM) 12MM

61.160.40 BIERER ASPIRATION CURETTE 11" (28CM) 14MM

61.160.50 BIERER ASPIRATION CURETTE 11" (28CM) 16MM

These uniquely designed curettes are all metal construction, have rounded ends to prevent perforation of the uterus, and length markings to indicate depth of introduction.

The double tube manufacture prevents clogging/obstruction.



BIERER

The curettes are supplied complete with rotating connectors for attaching to suction pumps. The illustration shows the connector attached to the Curette handle. Length stated is without the connector.

INDUCTION FORCEPS

The Goodwin amniotic forceps with its sharp teeth ruptures the membranes of the amniotic sac.

27
26
25
24
23
22
21
20
19
18

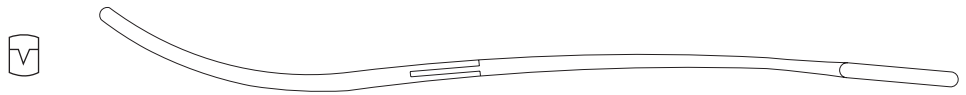

61.300.10 GOODWIN AMNIOTOMY FORCEP 10.25" (26CM) BOX JOINT

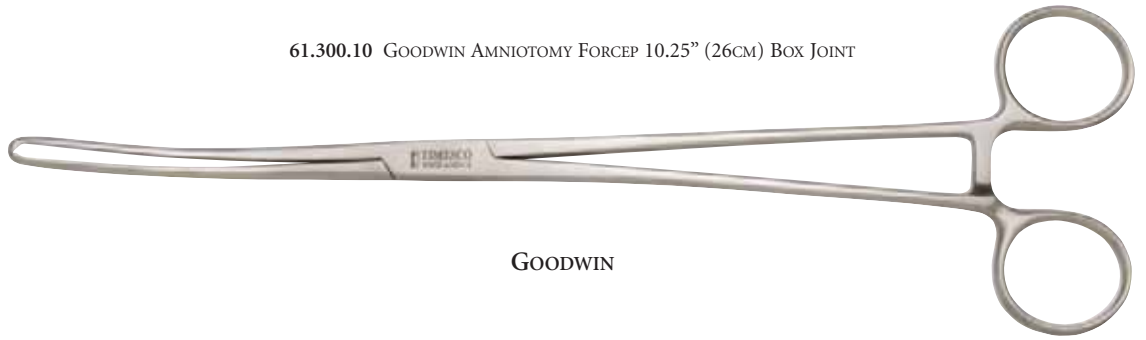

GOODWIN

OBSTETRIC FORCEPS

16
15
14
13
12
10
9
8
7
6
5
4
3
2



61.340.10 ANDERSON MIDWIFERY FORCEP 15" (38CM)

ANDERSON

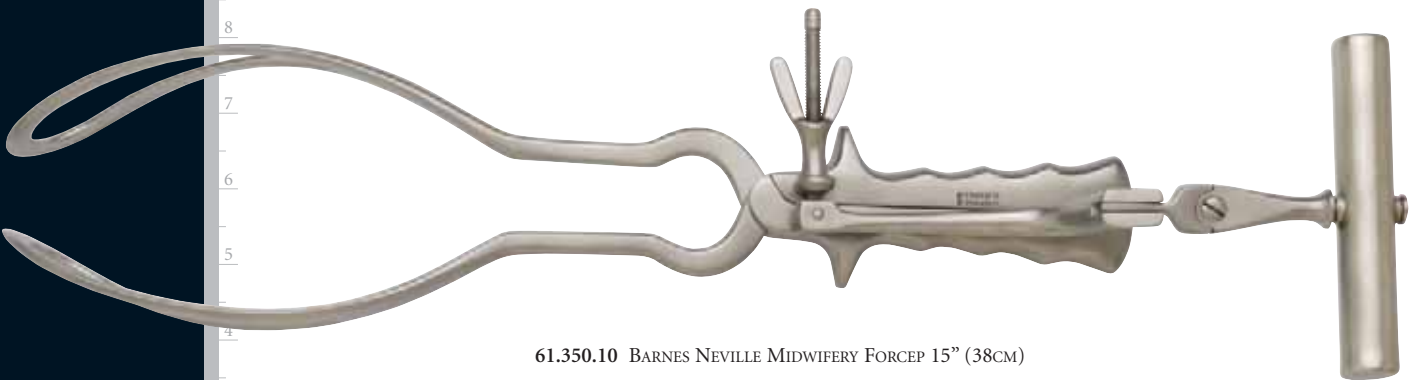

61.350.10 BARNES NEVILLE MIDWIFERY FORCEP 15" (38CM)

BARNES NEVILLE
with Axis Traction



61.360.20 DE LEE MIDWIFERY FORCEP 12" (30.5CM)

DE LEE

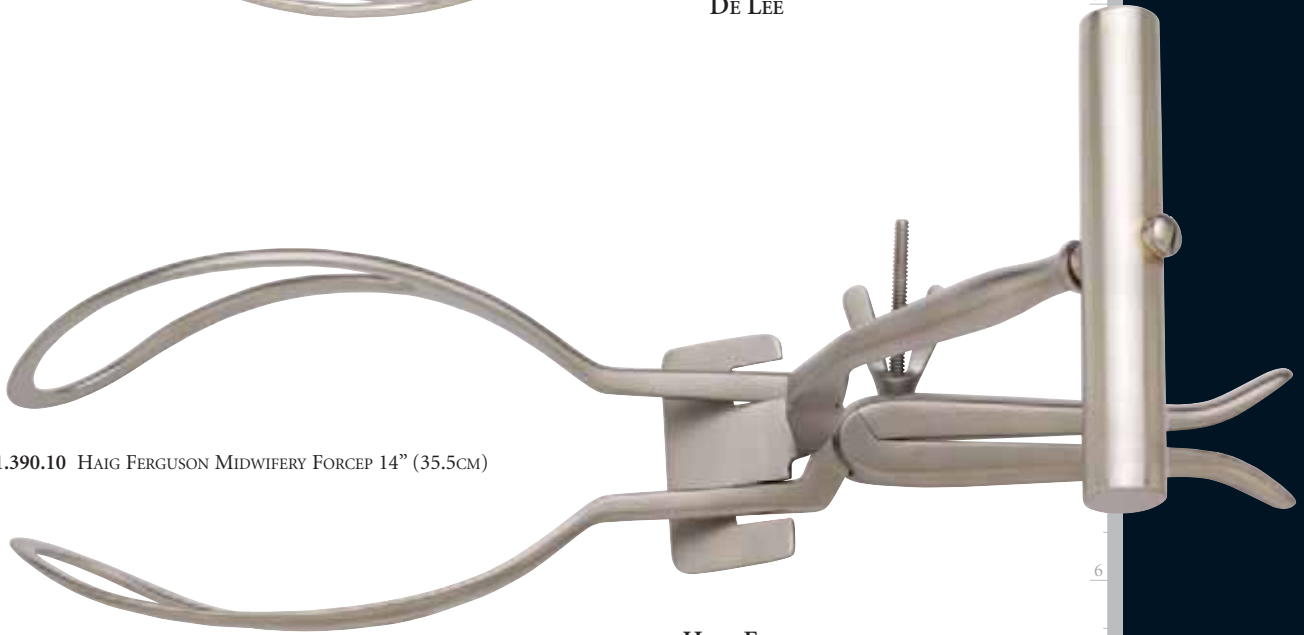

61.390.10 HAIG FERGUSON MIDWIFERY FORCEP 14" (35.5CM)

HAIG FERGUSON
with Axis Traction



61.420.10 KIELLAND MIDWIFERY FORCEP 16" (40.5CM)

KIELLAND



61.430.20 KIELLAND LUIKART MIDWIFERY FORCEP 15.5" (39.5CM)

KIELLAND LUIKART

OBSTETRIC FORCEPS

61.480.10 MILNE MURRAY MIDWIFERY FORCEP 13" (33CM)

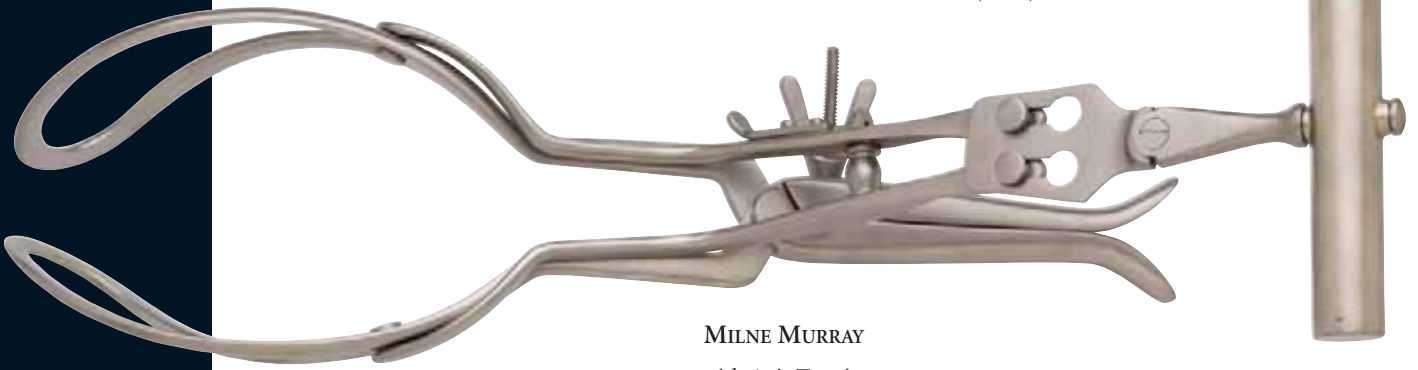

MILNE MURRAY
with Axis Traction

61.520.20 SIMPSON MIDWIFERY FORCEP 11" (28CM)

61.520.40 SIMPSON MIDWIFERY FORCEP 15" (38CM)



SIMPSON

61.550.10 TARNIER MIDWIFERY FORCEP 15.75" (40CM)



TARNIER
with Axis Traction

61.560.10 WRIGLEY MIDWIFERY FORCEP 11" (28CM)



WRIGLEY



MUCOUS EVACUATORS

61.580.10 CARTON MUCOUS EVACUATOR 9" (23CM)



CARTON
(Also known as 'Marshall Cowell')

This is used for clearing the upper air passages in the treatment of Asphyxia Neonatorum.

The bulbous chamber has cotton wool placed inside it, which acts as a trap when mucus is aspirated by sucking from the proximal end (the distal end being placed in the patient's throat).

OVUM/PLACENTA FORCEPS

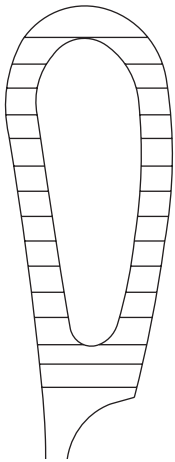

61.600.10 BIERER OVUM FORCEP 11" (28CM) SCREW JOINT

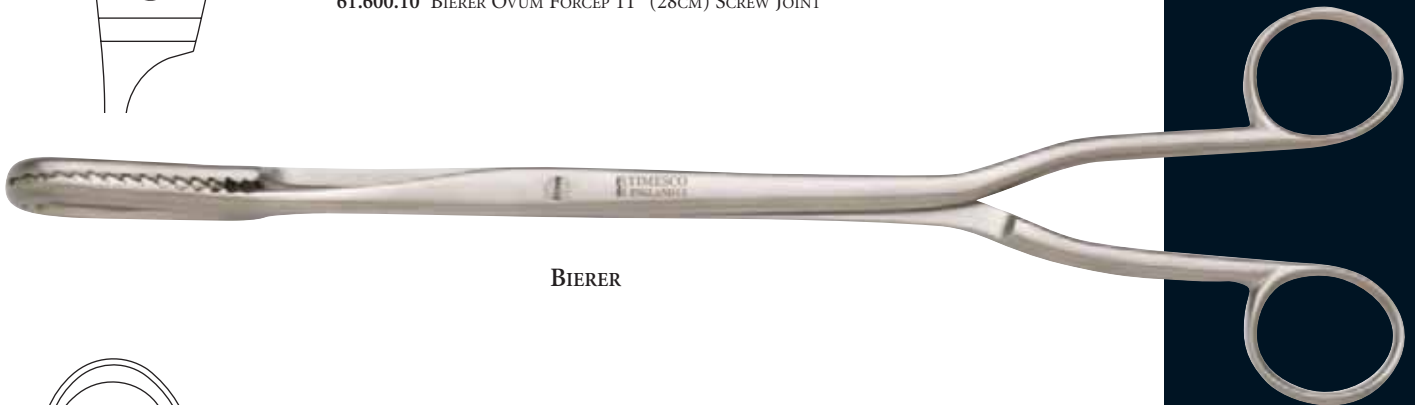

BIERER

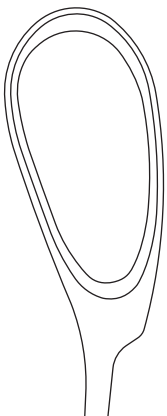

61.610.10 GREENHALGH OVUM FORCEP 9.5" (24CM) SCREW JOINT

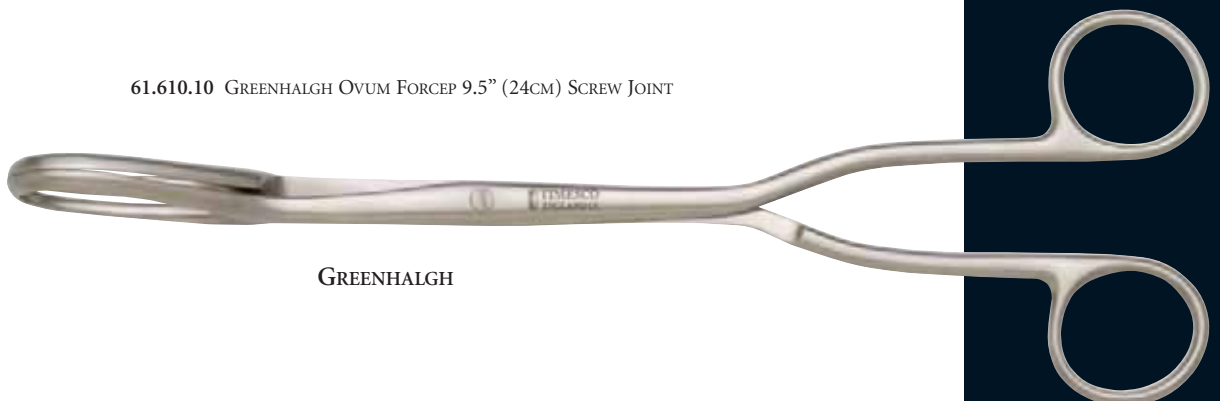

GREENHALGH

OVUM/PLACENTA FORCEPS

Ovum forceps are forceps which are also referred to as 'Placenta' forceps. These forceps feature large jaws, some with 'cups' for holding the ovaries, and are used to hold placenta, ovum and any excised tissue from the uterus.



61.620.10 HEYWOOD SMITH OVUM FORCEP 10.5" (27CM) SCREW JOINT



HEYWOOD SMITH

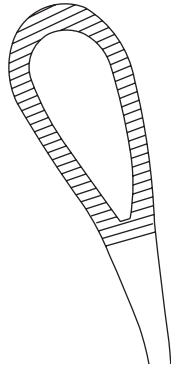

61.640.10 MCLINTOCK OVUM FORCEP CURVED 9.5" (24CM) SCREW JOINT



MCLINTOCK

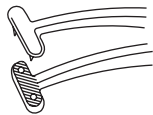

Not to scale

61.780.10 WILLETT PLACENTA FORCEP 7.5" (19CM) SCREW JOINT

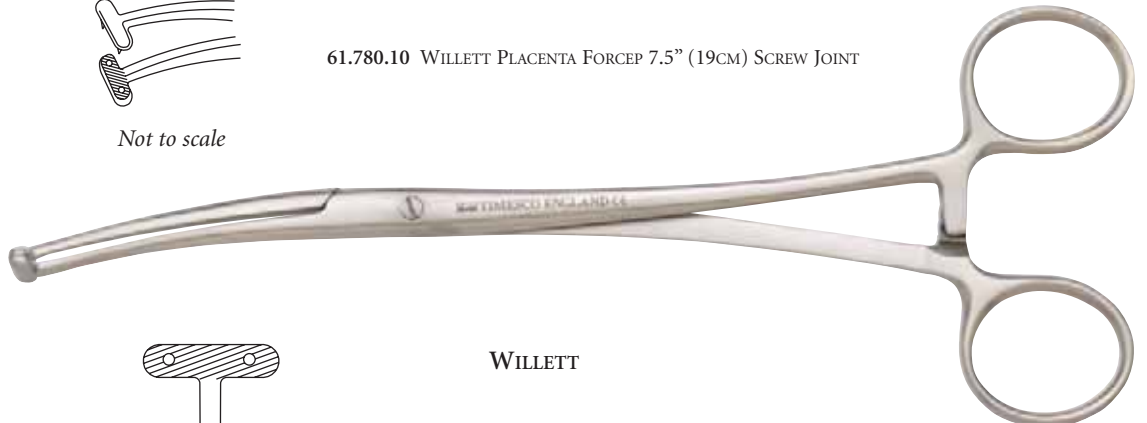

WILLETT

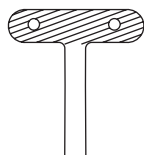

As its name suggests the Willett forceps are designed especially for holding the afterbirth.

The jaws feature serrations and two sharp conical pins, which securely hold without slipping. These forceps due to their strong non-slip action are also used extensively in cranial surgery to hold the skull flap.

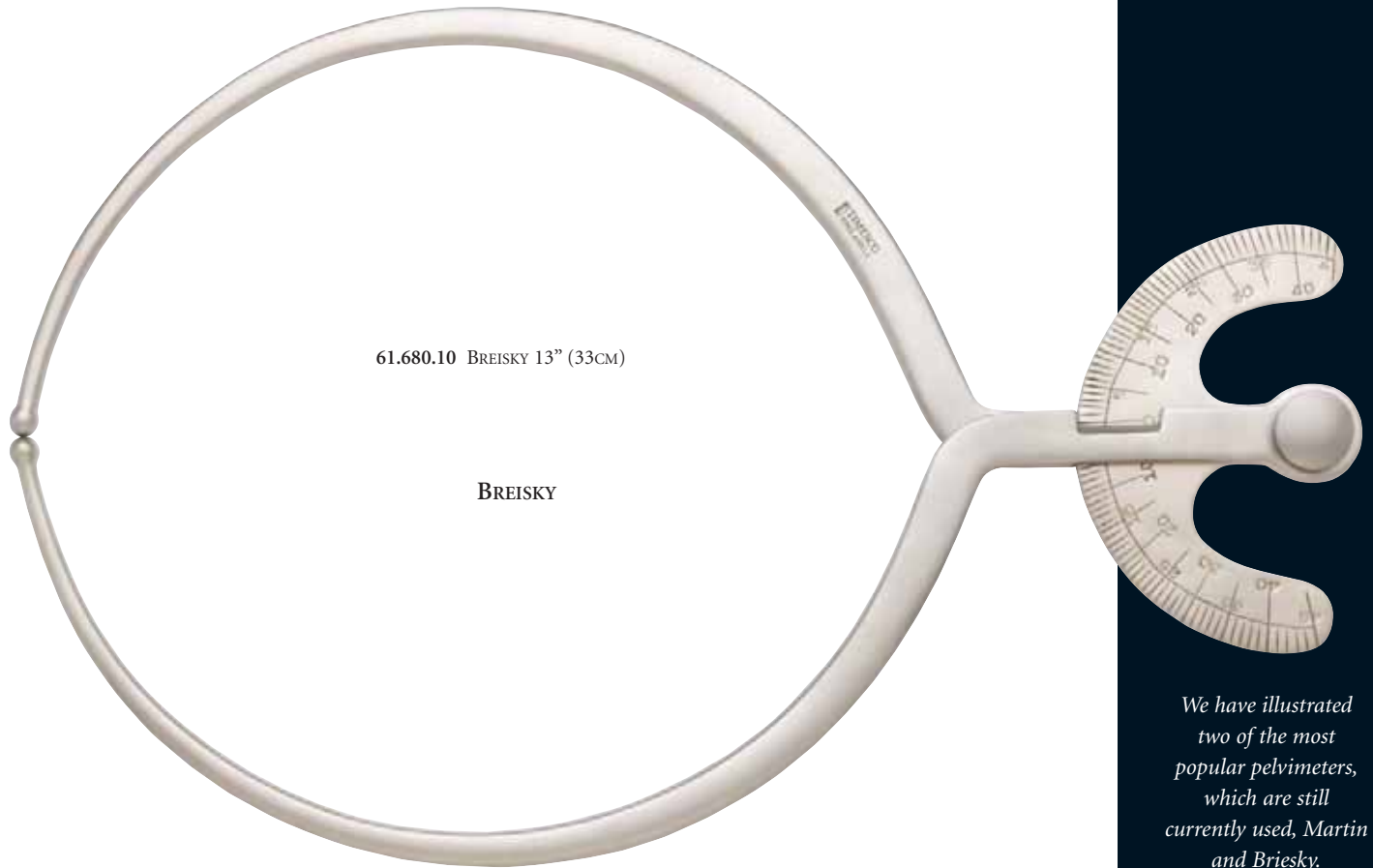

61.680.10 BREISKY 13" (33CM)

BREISKY

We have illustrated two of the most popular pelvimeters, which are still currently used, Martin and Briesky.

Pelvimeters are Calipers used to measure the size of the abdomen, ie. estimate the size of the child, and are precision graduated with a scale in MM/CM.

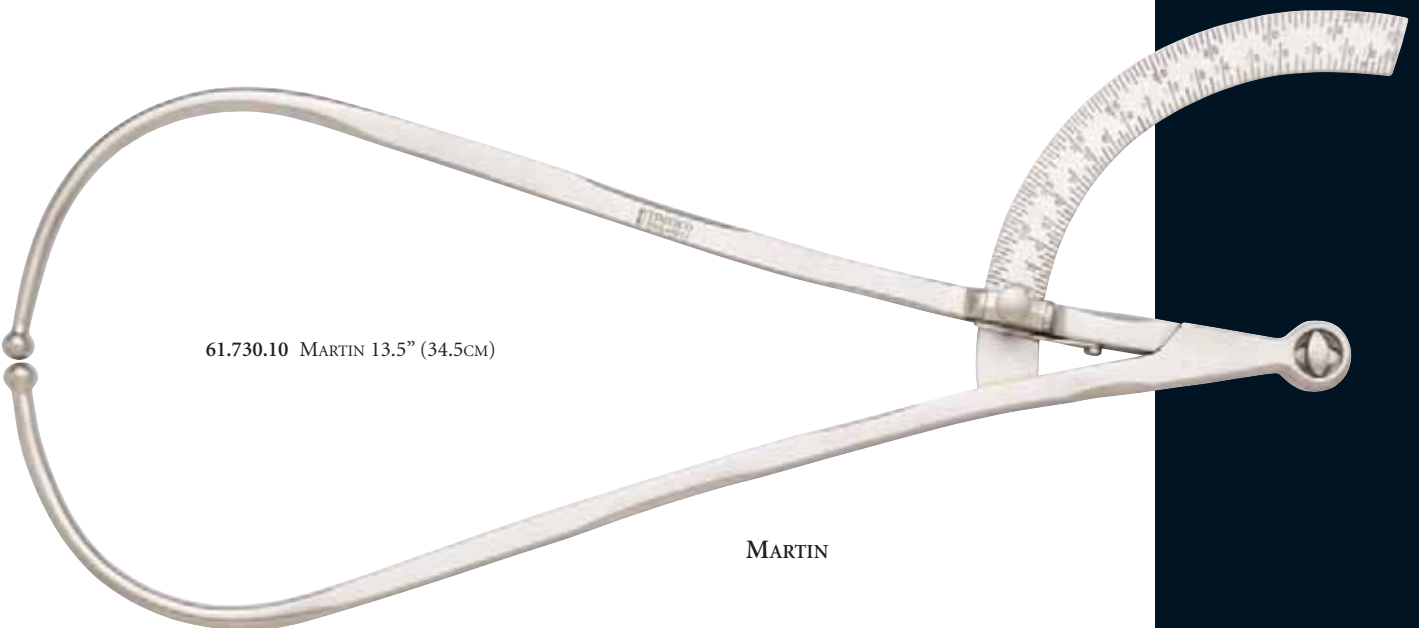

61.730.10 MARTIN 13.5" (34.5CM)

MARTIN

PERFORATORS

27

61.760.10 DENMAN 10" (25.5CM) SCREW JOINT



DENMAN

24

23

22

21

61.770.10 SIMPSON 11.25" (28.5CM) SCREW JOINT



SIMPSON

20

18

17

16

UMBILICAL DILATORS

These are used to dilate the umbilical artery to obtain blood samples in newborn babies.

14

13

12

11



61.810.10 UMBILICAL 3.75" (9.5CM)



STETHOSCOPES

The Pinard or versions of the same were first introduced in wood, ivory, Bakelite and then finally in metal and plastic. Timesco now offer this product in lacquered wood, aluminium and various colours of plastic.

9

8

7

6

5

4

3

2



03.350.10 PINARD STETHOSCOPES 5" (13CM) PLASTIC BLACK



03.360.20 PINARD STETHOSCOPES 6" (15CM) ALUMINIUM

COMPARISON TABLE OF DIAMETERS AND GAUGES

| DIAMETERS MM | FRENCH GAUGE (FG) | ENGLISH GAUGE (EG) | DIAMETERS MM | FRENCH GAUGE (FG) | ENGLISH GAUGE (EG) |
|--------------|-------------------|--------------------|--------------|-------------------|--------------------|
| 0.33 . | 1 | - | 9.00 | 27 | 16 |
| 0.50 ° | - | 00 | | | |
| 0.66 ° | 2 | - | 9.33 | 28 | - |
| 1.00 ° | 3 | 0 | | | |
| 1.33 ° | 4 | - | 9.50 | - | 17 |
| 1.50 ° | - | 1 | | | |
| 1.66 ° | 5 | - | 9.66 | 29 | - |
| 2.00 ° | 6 | 2 | | | |
| 2.33 ° | 7 | - | 10.00 | 30 | 18 |
| 2.50 ° | - | 3 | | | |
| 2.67 ° | 8 | - | 10.33 | 31 | - |
| 3.00 ° | 9 | 4 | | | |
| 3.33 ° | 10 | - | 10.50 | - | 19 |
| 3.50 ° | - | 5 | | | |
| 3.66 ° | 11 | - | 10.66 | 32 | - |
| 4.00 ° | 12 | 6 | | | |
| 4.33 ° | 13 | - | 11.00 | 33 | 20 |
| 4.50 ° | - | 7 | | | |
| 4.66 ° | 14 | - | 11.33 | 34 | - |
| 5.00 ° | 15 | 8 | | | |
| 5.33 ° | 16 | - | 11.50 | - | 21 |
| 5.50 ° | - | 9 | | | |
| 5.66 ° | 17 | - | 11.66 | 35 | - |
| 6.00 ° | 18 | 10 | | | |
| 6.33 ° | 19 | - | 12.00 | 36 | 22 |
| 6.50 ° | - | 11 | | | |
| 6.66 ° | 20 | - | 12.33 | 37 | - |
| 7.00 ° | 21 | 12 | | | |
| 7.33 ° | 22 | - | 12.50 | - | 23 |
| 7.50 ° | - | 13 | | | |
| 7.66 ° | 23 | - | 12.66 | 38 | - |
| 8.00 ° | 24 | 14 | | | |
| 8.33 ° | 25 | - | 13.00 | 39 | 24 |
| 8.50 ° | - | 15 | | | |
| 8.66 ° | 26 | - | | | |

Timesco is internationally recognised as one of the leading producers and suppliers of theatre quality (OR) surgical instruments and medical products. We produce products covering a vast spectrum of surgical and medical applications. Please contact your local Timesco Territory Manager or your local Timesco distributor for details on our full range, or visit our website at www.timesco.com

INSTRUMENTS FOR LIFE™



SURGICAL

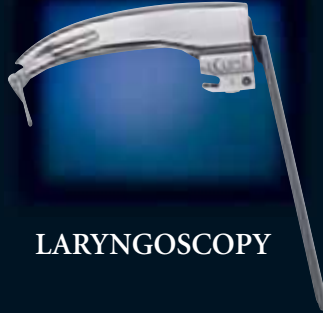

LARYNGOSCOPY



EMERGENCY



FOOTCARE



DENTAL



DIAGNOSTIC

DEALER INFO:



Timesco of London, Timesco House, 1 Knights Road, London E16 2AT.
Telephone: +44 (020) 7511 9960 Fax: +44 (020) 7511 7888 Email: info@timesco.com
www.timesco.com



E & O.E. Copyright January 2005. Ref C.G.001/1
'Timesco' and 'Instruments for Life' are registered trademarks of Timesco of London. All rights reserved.

